

# Wireless World

RADIO • ELECTRONICS • ELECTRO-ACOUSTICS

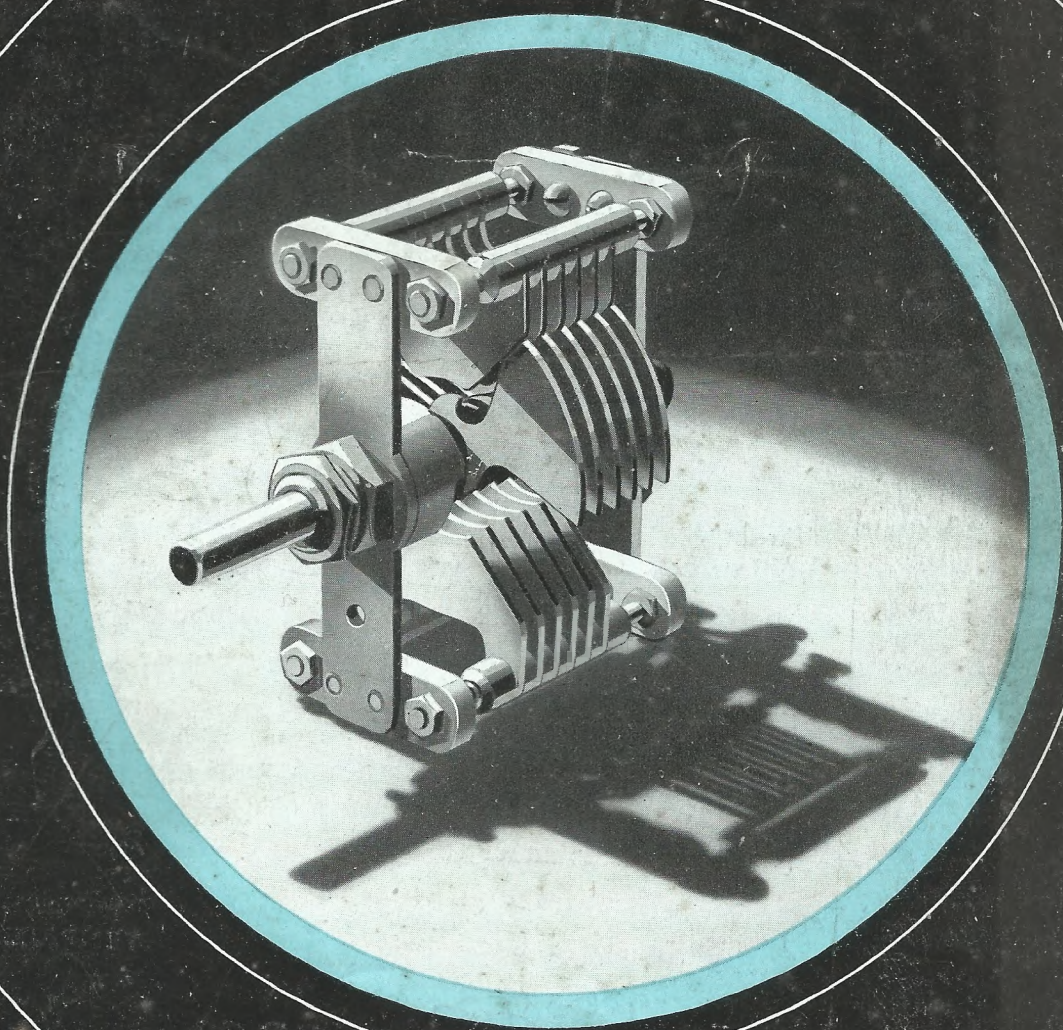

APRIL 1942

1/-

Vol. XLVIII No. 4

SHORT-WAVE DISTURBANCES ✦ "HOMODYNE" RECEPTION

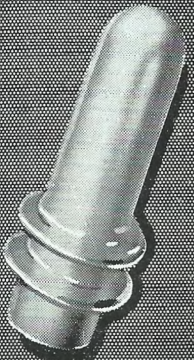
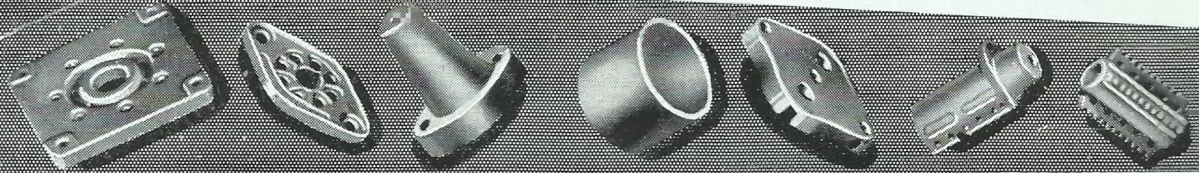

*Going one better*

**IN COMMUNICATIONS**



To-day, wherever Bullers Low Loss Ceramics are used, reception is clearer and better than ever before.

Years of research in Bullers Laboratories have developed these materials to such a high level of efficiency that Dielectric Loss is virtually eliminated. Bullers Ceramics are now playing a vital part in maintaining communications under all conditions.

**Made in Three Principal Materials :**

**FREQUELEX.** An Insulating material of Low Dielectric Loss. For Coil Formers, Aerial Insulators, Valve Holders, etc.

**PERMALEX.** A High Permittivity Material. For the construction of Condensers of the smallest possible dimensions.

**TEMPALEX.** A material of medium permittivity of Condensers having a constant capacity at all temperatures.

**BULLERS LIMITED**

THE HALL, OATLANDS DRIVE, WEYBRIDGE, SURREY

Telephone : Walton-on-Thames 2451

Manchester Office : 196 Deansgate, Manchester.

**Bullers**

**LOW LOSS CERAMICS**



Pollard

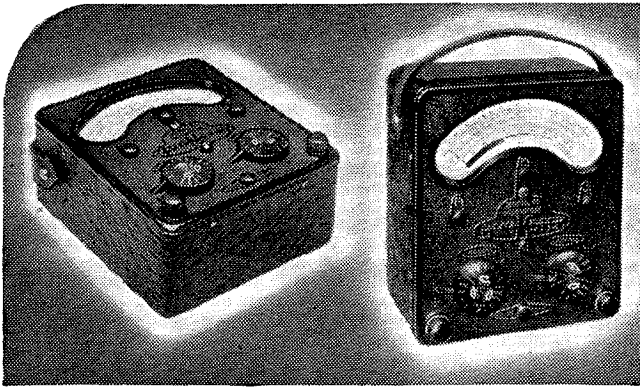

46-range Model 7 Universal AvoMeter

40-range model 40 Universal AvoMeter

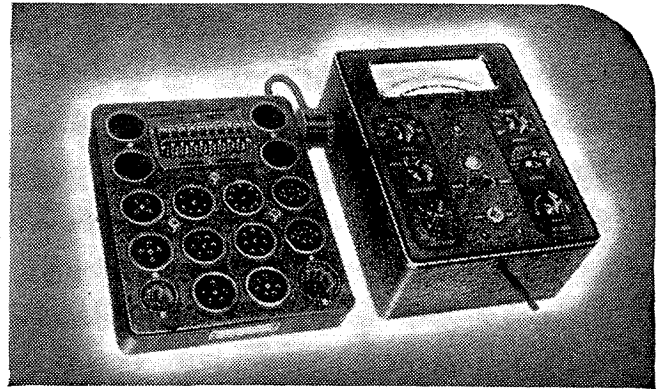

"Avo" Valve Tester with Universal Panel

# PRECISION METERS that Master every Testing Problem

The world-wide use of "AVO" Instruments is striking testimony to their outstanding versatility, precision and reliability. In every sphere of electrical test work—laboratory, shop or out on a job—they are appreciated for their dependable accuracy, which is often used as a standard by which other instruments are judged. There is an "AVO" Instrument for every essential electrical test.



## ELECTRICAL MEASURING INSTRUMENTS

BRITISH MADE

● Write for fully descriptive literature dealing with any instrument in which you are interested, and for current prices.

Some delay in delivery of Trade Orders is inevitable but we shall continue to do our best to fulfil your requirements as promptly as possible.

Sole Proprietors and Manufacturers:—

**THE AUTOMATIC COIL WINDER & ELECTRICAL EQUIPMENT Co., Ltd., Winder House, Douglas St., London, S.W.1**

'Phone: Victoria 3404-7

All-Wave "Avo" Oscillator

"Avo" Test Bridge

Universal AvoMinor

D.C. AvoMinor

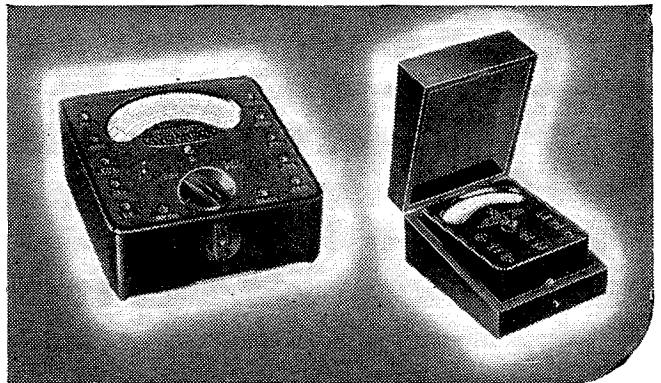
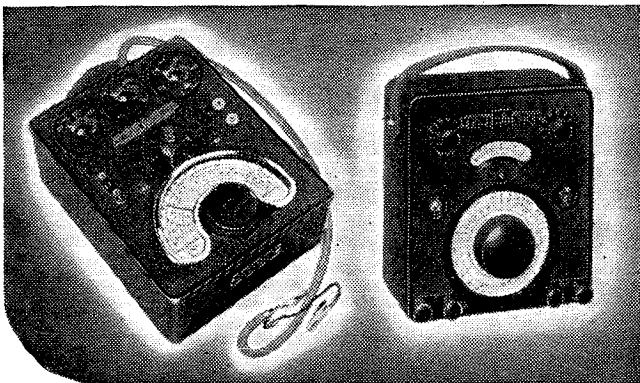

**SOLDER THE MODERN & SPEEDY WAY**

# MULTICORE

*The Solder Wire with  
3 CORES  
OF NON-CORROSIVE  
ERSIN FLUX*



(PHOTO: COURTESY 'H.M.V')

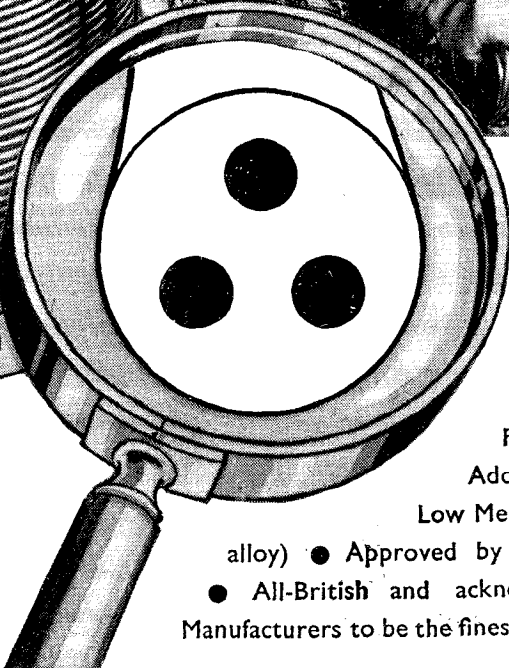

**FREE**—Two informative publications on soldering have been issued by Multicore Solders Ltd. Executives are invited to send for copies and a free sample of Multicore Solder.

- Avoids Dry Joints
- Increases Electrical Efficiency of Joints
- Speedily makes Sound Joints on Dirty or Oxidised Surfaces
- Always Correct Proportions of Flux and Solder
- No Additional Flux Required
- Low Melting Point (190° C. for 60/40 alloy)
- Approved by Air Ministry and G.P.O.
- All-British and acknowledged by the Leading Manufacturers to be the finest Cored Solder in the world.

**MULTICORE SOLDERS LTD., BUSH HOUSE, LONDON, W.C.2**



## The stars

look down . . .

. . . upon the sleeping villages and towns of England. Over the peaceful scene the moon mounts guard with watchful eye. Yet, at any given moment, should the necessity arise, the quietest country village can be in instant communication with the greatest city; can command its resources and enlist its help. Our products for many years have served in spreading human happiness and in forging links between men, and to-day we still proudly play our part in maintaining human fellowship.

**DUBILIER**  
CONDENSER CO. (1925) LTD.

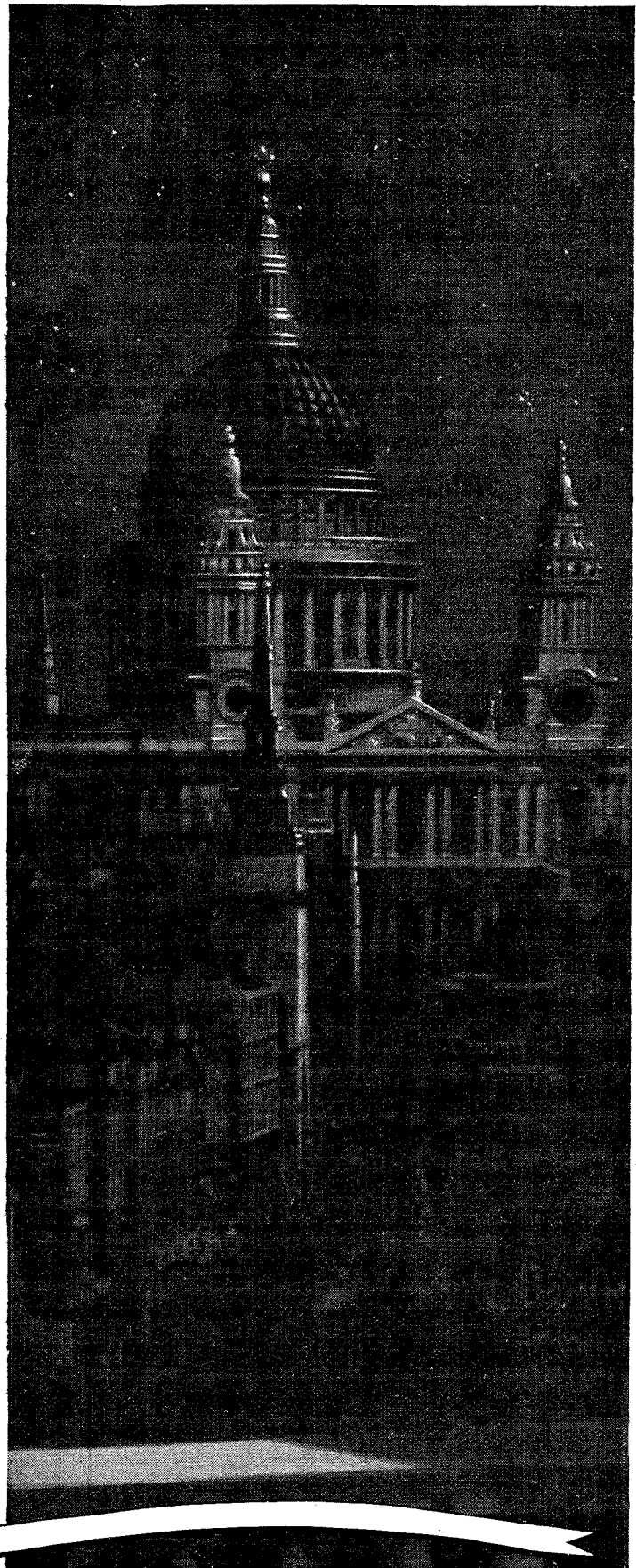

# WEBB'S *Radio*

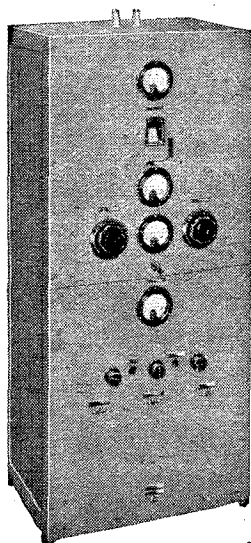

**Retail Sales and Mail Order Dept.** Despite staff shortages and other difficulties we are still able to offer practically any component required by the short-wave enthusiast, at our Retail Sales Dept. 14, Soho Street. **Mail Order Dept.:** Though also short-staffed, this department provides an efficient and careful service.

**Service of Communication Receivers.** A restricted service can now be given on all types of Communication Receivers. Please do not despatch instruments without first communicating with us.

**Special Products Dept.** This department offers very useful facilities for the construction of specialised equipment for transmission and reception. One of its recent productions—a 75-watt 'phone and C.W. Transmitter—is illustrated on the left.

## A WARTIME SERVICE

Since the war short wave radio has become of immense importance and the radio man very often finds his activities restricted. Nevertheless, Webb's Radio can still provide a great many facilities both to amateurs and priority holders. A few of these services are described here:—

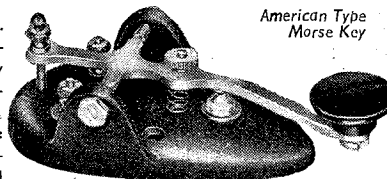

American Type  
Morse Key

New lines are continually being introduced, and among the latest is an American type Morse key; very light in operation, price 8/6. Other lines include a 50-watt audio amplifier and an audio oscillator for Morse practice. This latter instrument, Type O.A.1, is entirely operated from A.C. mains, gives a 1,000 cycle note, and drives two pairs of 'phones. Price £2 5s., including two valves.

**Woden Transformers and Amplifiers.** A full range of the stock lines manufactured by the Woden Transformer Co. is carried and arrangements made for rapid delivery of special non-standard items.

**Bandpass Crystal Filter Units by Simmonds Aerocessories, Ltd.** The retail distribution of these units is being made exclusively through Webb's Radio. They are suitable for use generally with communication type receivers and can be supplied in several band widths. Full technical specification and details on request.

**United Insulator Co., Ltd.** A wide range of these well-known products, which include Silvered Mica Fixed Condensers, Silvered Ceramic Fixed Condensers, etc. are also available from stock. Webb's Radio are sole distributors to trade and user.

Ceramic  
Trimmer  
Condenser.

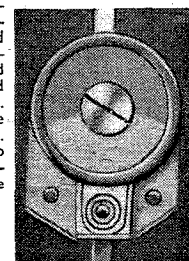

**WEBB'S RADIO, 14, SOHO STREET, LONDON, W.1.**  
Phone: GERrard 2089. Hours of Business: 9 a.m.—5 p.m. Saturdays 9 a.m.—12 noon

## TANNOY

Regd. TRADE MARK

Proprietors: GUY R. FOUNTAIN Ltd.

TANNOY is the Registered Trade Mark of Guy R. Fountain Ltd. Whenever you see Loud Speaking Equipment bearing the Trade Mark TANNOY it indicates the goods of the Registered Proprietors, Guy R. Fountain Ltd.

Whenever you hear the Trade Mark TANNOY used in relation to Loud Speaking Equipment it indicates a connection in the course of trade between the goods and the Registered Proprietors,

**Guy R. Fountain Ltd.**  
Canterbury Grove, West Norwood,  
S.E.27. Telephone: GIPsy Hill 1131  
—and Branches—

**TANNOY**  
Registered Trade Mark

## TRANSFORMERS

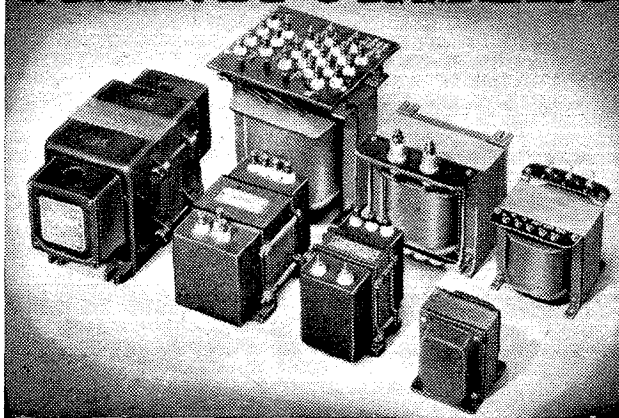

\* Woden are specialists in small transformer construction.

\* All types are available including shrouded transformers, which give full winding protection and prevent interaction in radio apparatus.

\* Porcelain insulators on high voltage terminals give protection from flash-over.

\* Available in quantities for production. Specially quick delivery of singles for Government Department research work.

**WODEN TRANSFORMER CO.**  
Thornley St., Wolverhampton  
Tel.: Wolverhampton 22829.

MAKERS OF TRANSFORMERS, POWER PACKS, AND SPECIAL RECEIVING AND TRANSMITTING APPARATUS.

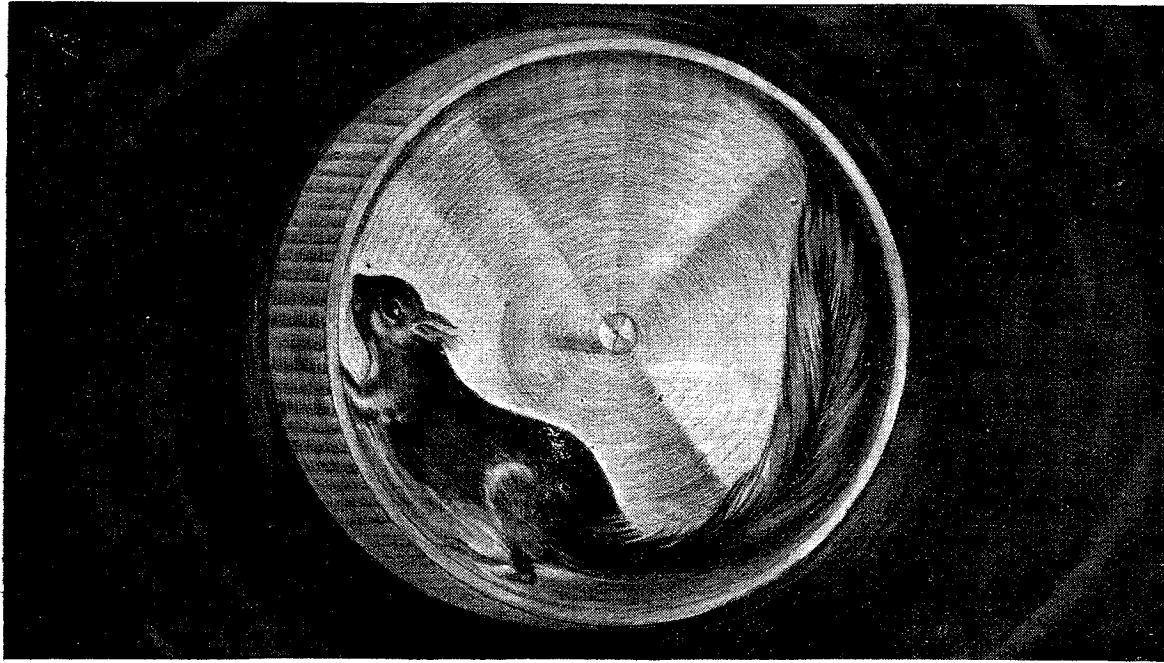

## Not Much Progress

THE very pressure under which industry is working to-day renders it sometimes inevitable that methods should persist which, already barely adequate, will prove quite out of date as the war proceeds.

Not later on but now is the time to overhaul those methods, to examine the new and more efficient means of production which are available. In numberless fields of industrial activity the Simmonds Organization, after a careful study of conditions, has evolved a product which specifically solves a vital problem of design or manufacture with the complete success born of highly specialized knowledge and experience.

# S I M M O N D S

THE SIMMONDS "SIA" NUT  
 SIMMONDS-CORSEY CONTROLS  
 SIMMONDS CONTENTS GAUGES  
 FOR AIRCRAFT.  
 SIMMONDS POSITION INDICATORS  
 SIMMONDS ELECTRIC TEMPERATURE  
 AND PRESSURE GAUGES  
 SIMMONDS AIRCRAFT FLOORING



SPIRE "SIA" NUTS  
 FRAM OIL & ENGINE CLEANER  
 SIMMONDS INDUSTRIAL AND  
 MARINE CONTENTS GAUGES  
 SIMMONDS JOINTING COMPOUND  
 SIMMONDS CRYSTAL UNITS  
 SIMMONDS-GOUDIME  
 NAVIGATIONAL INSTRUMENTS

**SIMMONDS AEROCESSORIES LTD**

A COMPANY OF THE SIMMONDS GROUP  
 LONDON · MELBOURNE · PARIS · NEW YORK

P-3

ALL ENQUIRIES TO GREAT WEST ROAD, LONDON.

# U.I.C.

## CONDENSERS & COMPONENTS For Modern Radio Technique

- 1 CERAMIC PEARL TYPE CONDENSERS
- 2 CERAMIC COIL FORMERS
- 3 SILVERED MICA (Tropical Type) CONDENSERS
- 4 POT CONDENSERS
- 5 FIXED CERAMIC CONDENSERS
- 6 CERAMIC TRIMMER CONDENSERS

Full details and advice gladly given.

CONTRACTORS TO G.P.O. & GOVERNMENT DEPARTMENTS.  
ON A.I.D. APPROVED LIST.

**UNITED INSULATOR CO. LTD.**

12-20, LAYSTALL ST., LONDON, E.C.1

Phone: TERminus 7383.

Grams: "CALANEL, SMITH, LONDON."

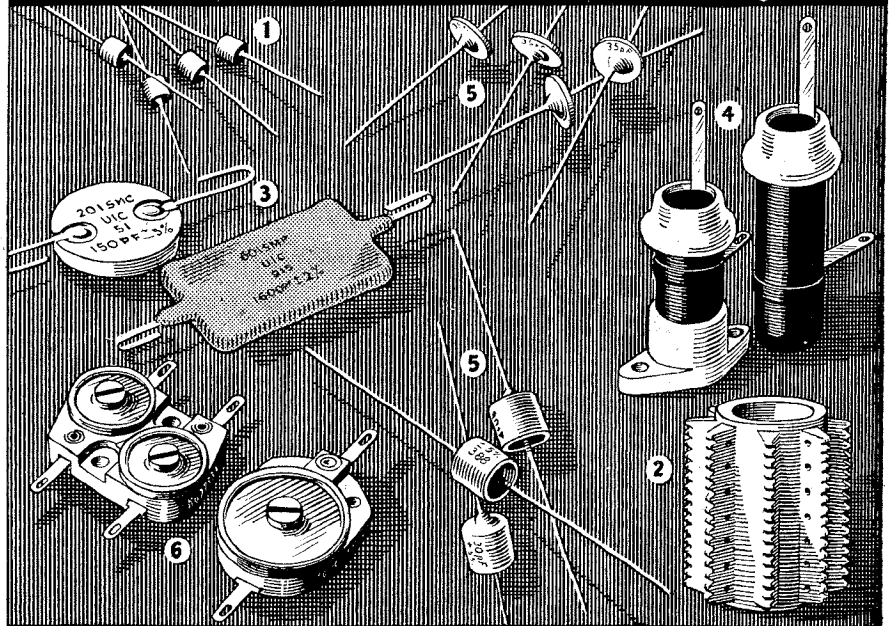

*The Pioneers of Low Loss Ceramics*

## THE POWER BEHIND-



The Perfect Portable Power Supply in service under arduous conditions in Transmitters, Receivers, Amplifiers, etc.

*Masteradio* LTD. GRAMS: MASTIOLA  
PHONE: WATFORD 9885/9889  
VIBRANT WORKS, WATFORD, HERTS.

Greenwood

# CELESTION

### CELESTION-AMPHENOL

valveholders are preferred by radio engineers because of their Strength, Efficiency, Uniform Contact and exceptional Insulation.

All standard British and American types are available.



BRITISH MADE

BRITISH MADE

**CELESTION LTD.**

(Engineers).

KINGSTON-UPON-THAMES, SURREY.

Telephone: KINGston 5656-7-8.



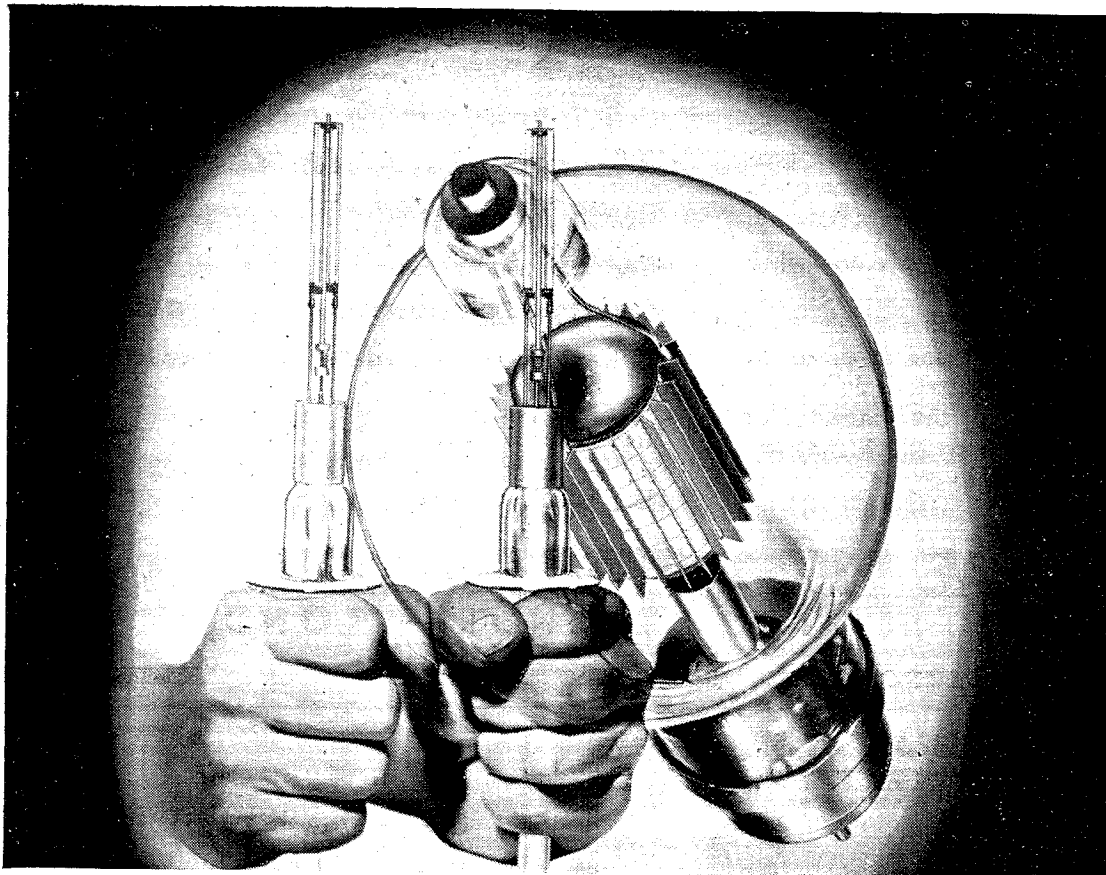

### How Important is a Filament?

It's a well known fact that the vacuum valve is the heart of radio communications, but it is important to remember that the filament is the heart of the vacuum valve! Thus, the efficiency with which these tiny strands of tungsten wire perform may mean the difference between success and failure of the valve itself...victory and defeat for tanks or battleships...life and death for millions of people.

You can't always tell by appearance whether a filament is efficient or not. The two assemblies shown above look exactly alike but when put to the test one may not do its job. Into the production of filament for Eimac valves has gone much research and experimentation. Among many special instruments designed and perfected by Eimac to insure perfect filaments, none is more interesting than the electron microscope which virtually gives a moving picture of how a filament works under actual operating conditions.

Behind every Eimac valve is the assurance that its filament will function at top efficiency. Contributing factors to this efficiency are: Tantalum plates and grids and the super-vacuum which removes all contaminating gas particles. All these factors and more are what make it possible for Eimac valves to carry the unconditional guarantee against emission failure caused by gas released internally.

*Eimac's unusual performance capabilities are receiving enthusiastic acceptance in all branches of the service...ARMY, NAVY and AIR CORPS*

Follow the leaders to



Eitel-McCullough, Inc.  
San Bruno, California

Foreign Division: FRAZAR & CO., LTD., 301 Clay Street, San Francisco, California, U. S. A.

# "to Insulate"

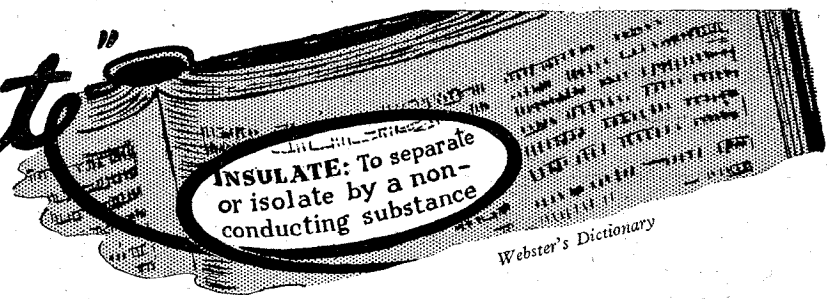

Practically all waxes are used to "separate or isolate," but the degree of insulation provided by the different types of waxes varies enormously.

There is obviously no higher degree of insulation required than that of electrical components and apparatus in intense electrical fields, especially in the extremes of conditions to which they are subjected to-day.

We specialise in the supply of

## WAXES for all purposes—under all conditions

Our technical advice is at your disposal.

If you have any problem of

**IMPREGNATING—DIPPING—FILLING**

we, as consultants to the Industry, shall be glad to offer you a solution.

# CLAUD CAMPBELL & CO. LTD.

4, LLOYDS AVENUE — LONDON — E. C. 3.

Telephone Nos. :—ROYAL 5403/4/5.

## M.R. SUPPLIES

again invite your urgent attention to the following very special offers of MICROPHONES and ELECTRO-TECHNICAL EQUIPMENT. All goods brand new, perfect and guaranteed and in stock at time of going to press. All prices strictly nett.

To-day's Greatest

### MICROPHONE OPPORTUNITY

(Last month's customers all "more than pleased")

#### ROTHERMEL-BRUSH PIEZO-CRYSTAL MICROPHONES

(as illustrated).

A model of really outstanding performance and appearance, incorporating the latest piezo-electric generating agent producing a level response to about 8,000 c/s. Output level—60db. In handsome satin-black housing with chromium bezel and knuckle-joint for angle adjustment. Mounting thread is 1/8 in. (26). Complete with 6 ft. screened lead.

72/6 nett

Supply is obviously limited and we respectfully advise early application. Instruction leaflet sent with each.

**MICROPHONE FLOOR STANDS.** Suitable for above. All chromium, collapsible music stand type, in square section tube, extending to 5ft. 6in. and collapsing to 2ft. Detachable mounting boss has 1/8 in. (26) thread, 36/6.

**MICROPHONE TABLE STANDS.** Also suitable for above mike. All chromium, extending 12in. to 18in., with heavy square base, 25/-.

**FRACTIONAL H.P. MOTORS.** Approx. 1/30th h.p. and suitable for cine, laboratory use, as motive power for grammo-motor (customer providing his own gearing), etc., 1,375 r.p.m., ball-bearing, reversible, silent running, capacitor start induction. Voltage 200/250 A.C. 50 c. Double-ended shaft. Housing dimensions 4in. by 3in., expensively made for reliable service, 47/6.

**ELECTRO-MAGNETIC RELAYS.** First-class manufacture, enclosed in steel case 4in. by 4in. by 2in. 12-volt D.C. coil with 2-pole break silver contact 10-amp. switch. Open-circuit when coil is energised (operation easily reversed). Brand-new precision instruments under contract price, 39/6.

**LOW-TENSION METAL RECTIFIERS,** D.C. delivery 12/14 v. 1.5 amp., 11/6.

**STEP-DOWN TRANSFORMERS** for above. Primary 200/250 v. (tapped) and secondary tapped for 4, 8 and 12 v. charging in connection with the rectifier at full 1.5 amp., 15/6.

**SLIDING RHEOSTATS** (100 watts capacity). Fully enclosed, with bushed cable entry and laminated contacts, 10 ohms 3 amps., 100 ohms 1 amp., or 200 ohms 0.7 amp., any one 18/6. Also a few S.H. Isenthal open type, 2.2 ohms 6 amps., 8/6.

**ROTHERMEL PIEZO-CRYSTAL CARTRIDGES,** the new die cast housed model, complete with needle screw. Enable one to renovate existing pickup or make replacement head for record player. (NOTE.—This model does not fit the S.8 or de Luxe pickup.) Limited number at 23/6 each.

**FERRANTI MICROPHONE TRANSFORMERS,** for moving coil microphones, pri., 10 ohms, sec., 5,000 ohms, high inductance, weight 3 1/2 lb., 15/6. (Some are very slightly soiled—ex Govt.)

Please estimate postage. Cash with order preferred owing to staff shortage.

**M.R. SUPPLIES, 68, New Oxford St., London, W.C.1**

Telephone : MUSeum 2958

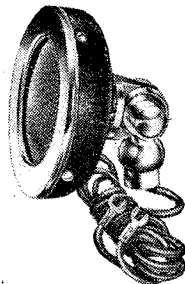

The

## British Institution of Radio Engineers

(Founded in 1925 as The Institute of Wireless Technology, Incorporated 1932)

The Graduateship and Radio Servicing Certificate Examinations are held in May and November of each year in principal centres throughout the World.

The revised Regulations Governing Membership, including detailed syllabus of examination, and copies of past examination papers (5/6 per four sets post free) may be obtained from:—

The British Institution of Radio Engineers,  
Duke Street House, Duke Street,  
London, W.1.

Telephone : Mayfair 5645.

The usual sessional activities are continuing and members of the Institution notified by circular of all arrangements.

A list of meetings (London, Midland, South Western and North Western Sections) and a full list of members are given in the Year Book of the Institution.

*"Rubber precisely bonded"*

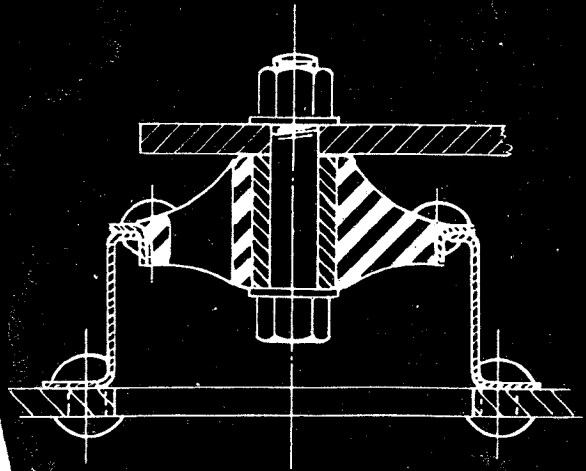

*Displacement  
under load within  
0.010 of requirements*

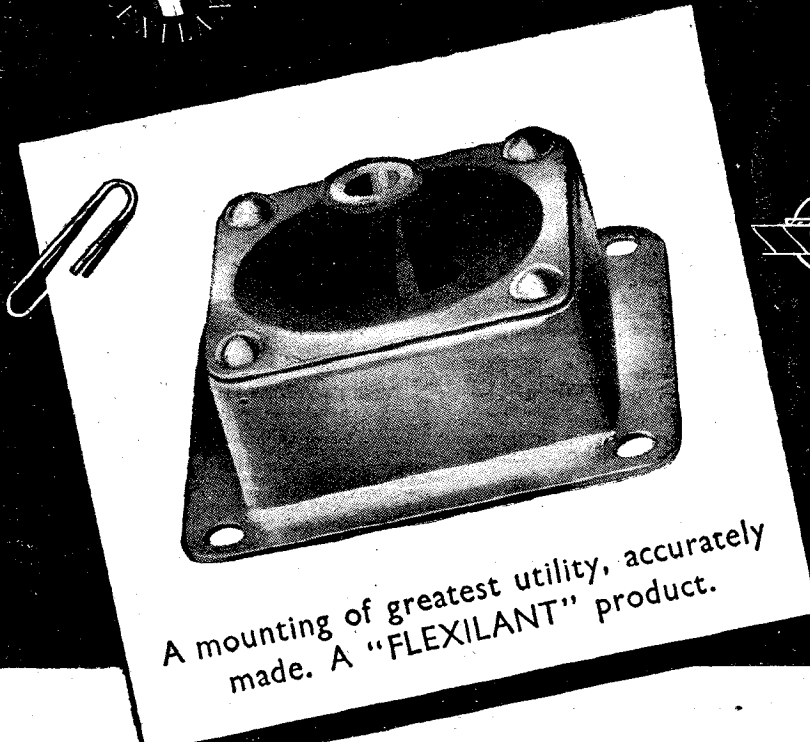

A mounting of greatest utility, accurately made. A "FLEXILANT" product.

This series of mountings is designed to carry loads of from 1 to 45 lbs. per mounting. They may be arranged with bolt axis at 90° to position, or the complete mounting may be inverted. Two mountings may be utilized on the same bolt if required.

Mountings can be used with or without holder. They are suitable for all types of instrument panels and provide adequate protection against vibration for the most delicate instruments. They provide electrical as well as vibration insulation.

*A semi-technical booklet entitled "A Short Review of 'FLEXILANT' Products" has just been published and is available upon enquiry.*

# RUBBER BONDERS LIMITED

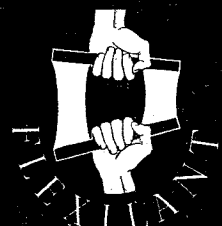

FLEXILANT WORKS: WATLING STREET.  
DUNSTABLE, BEDFORDSHIRE. PHONE: DUNSTABLE 715 · GRAMS: FLEXILANT DUNSTABLE.

RB.21.a

# RAYMART

CRAFT A CREED

ALL who are learning to become Wireless Telegraphy Operators and all who are acting as instructors for members of the A.T.C., Home Guard or the Signal Section of any branch of the Services must have reliable apparatus to work with.

IN placing before you the Raymart range of British made Keys and High Note Buzzer, we wish to impress upon you the fact that each Raymart instrument has been most carefully designed and assembled, is built to the highest standard of efficiency and is absolutely reliable in use.

SPECIAL TERMS can be offered to Schools, Training Establishments, Home Guards and A.T.C. Quantity enquiries from the Trade will receive every consideration.

# RAYMART

CRAFT A CREED

## WIRELESS TELEGRAPHY EQUIPMENT

### THE RAYMART "SPEED" KEY

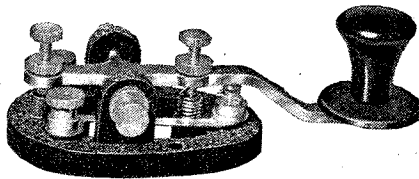

In designing the Raymart range of keys the importance of scientific weight distribution as an aid to practically effortless high-speed sending received special consideration. All parts are of best quality materials and are precision made. The knobs are of high-grade bakelite and the washer or paddle which is fitted below it is made of polished "Erinfort."

The contacts are of .jin. solid sterling silver. A high grade of spring is fitted and gap adjustment is easily and accurately carried out. The base of the key is drilled for two-hole screw fixing. The appearance of the instrument is all that can be desired, and the metal parts are instrument lacquer finished.

The Raymart "Speed" Key offers exceptional value for money ..... **PRICE 8/6**

### THE RAYMART HIGH NOTE BUZZER

An ideal British-made buzzer for Morse practice. Very robust, totally enclosed in bakelite case. Heavy coin silver contacts .... **PRICE 2/- (Post 3d.)**

48, HOLLOWAY HEAD

### STANDARD G.P.O. TYPE KEY

*Specification*  
The bar of this instrument is made from solid brass, .jin. by 5/16in.  
The pivot boss is of solid brass.  
The large brass knurled spring adjustment and spacing screws and locking nuts are of such diameter that close and permanent adjustment is easily effected.  
Solid Sterling Silver Contacts of approximately .jin. diameter are fitted.  
The heavy knob is made from bakelite and is highly polished and a turned and polished "Erinfort" washer or paddle is fitted below it.  
The Key will be lacquer instrument finish and the wood base is fully covered with sheet "Erinfort" which will preserve the appearance of the key throughout its long and useful term of service.

**PRICE 9/6**  
(Post 6d.)

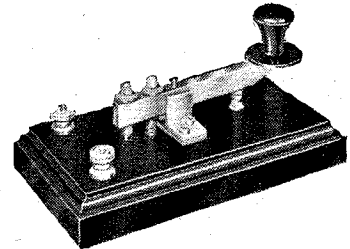

### THE RAYMART MORSE KEY KIT

Anyone can assemble the Raymart KIT of Parts for making a G.P.O. Type of Morse Key, in less than 10 minutes. The "Erinfort" cover for the wood base is ready drilled and acts as a template.  
This Kit of Parts is identical with those used for the Raymart Standard Key described in detail above, but you will need as a base a two-way switch block (cost only a few pence) and 2 terminals. Your local electrician can supply. (Post Free)

**THE KIT 7/6**

BIRMINGHAM, 1

Telephone: MIDLAND 3254



# MEICO

MOVING COIL MICROPHONES

IMMEDIATE DELIVERY

MICRAMATIC ELECTRICAL INSTRUMENT CO.  
360, Station Rd., HARROW, MDDX. Tel.: HAR 0663

## TAYLOR ALL-WAVE SIGNAL GENERATOR

(6.5 to 3,000 metres)

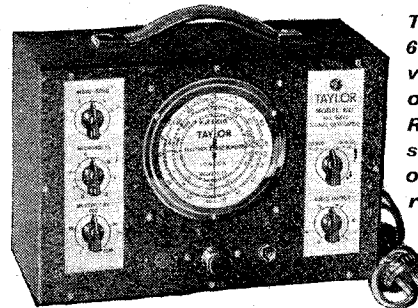

This Taylor Model 60 instrument provides modulated or unmodulated Radio frequency signals for tests on all types of receivers.

**ALL-WAVE** (100 Kc. to 46 Mc. in 6 wavebands).  
**DIAL** directly calibrated in frequency. No graphs required.

**A.C.** Mains drive.

**COARSE** and fine attenuation giving an output smoothly variable from 0 to 100,000 microvolts.

**RADIO OUTPUT** either unmodulated or modulated at 400 cycles or externally modulated.

**400 CYCLE** output of good waveform available separately and adjustable from 0 to 5 volts.

**FULLY SCREENED** and no direct radiation from generator.

British made by

**TAYLOR**

**TAYLOR ELECTRICAL INSTRUMENTS LTD.**  
Instrument Sales and Service Department,  
148a High Street, Slough, Bucks.  
Telephone: Slough 21383

**TAYLOR MODEL 60**  
**£14.14.0**

Supplies complete with screened output lead, instruction book and frequency conversion table.  
WRITE FOR LIST, ETC.

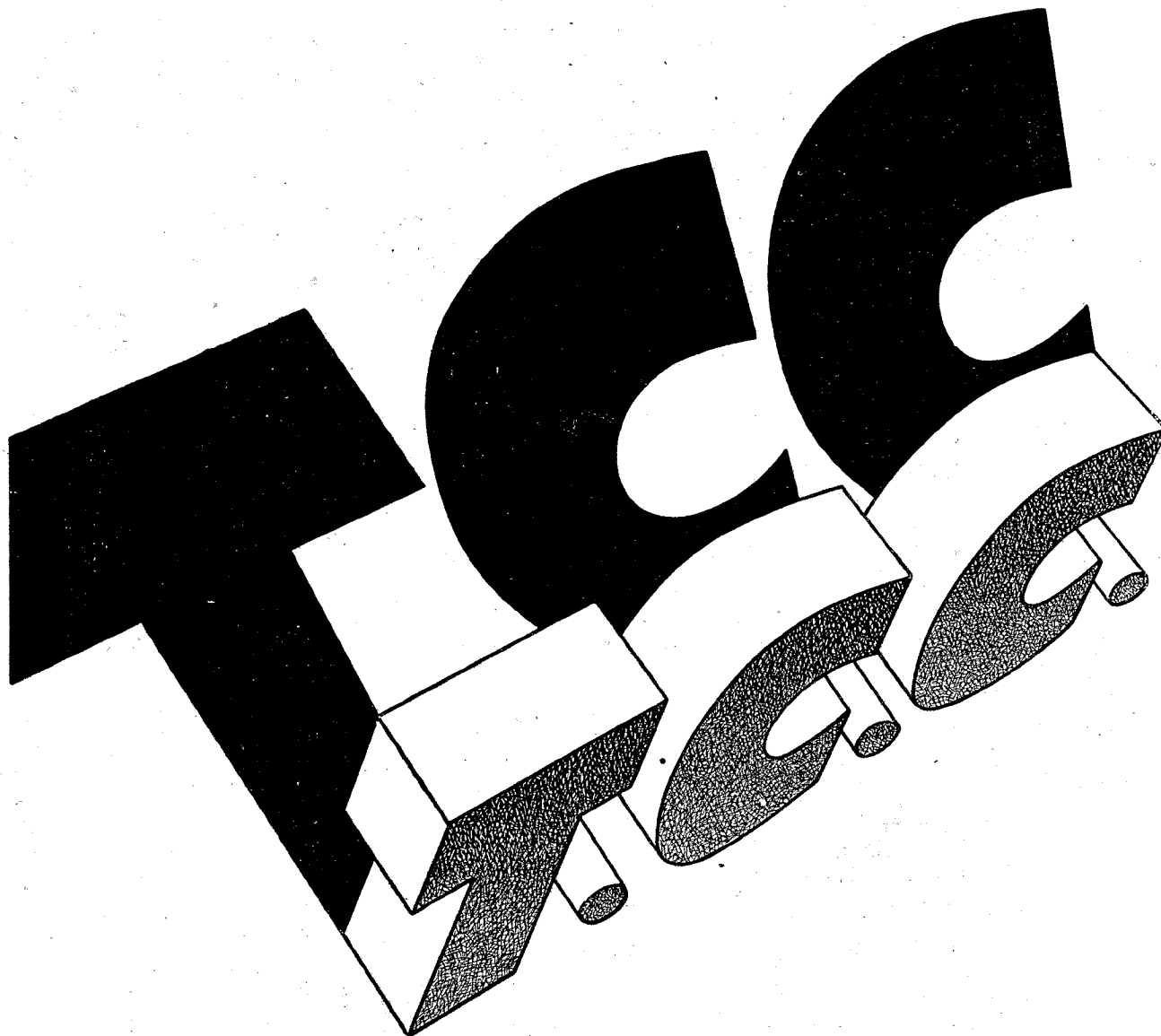

**PRE-EMINENT IN PEACE  
INDISPENSABLE IN WAR**

**ADVERTISEMENT OF THE TELEGRAPH CONDENSER CO., LTD.**

G.P. 5253

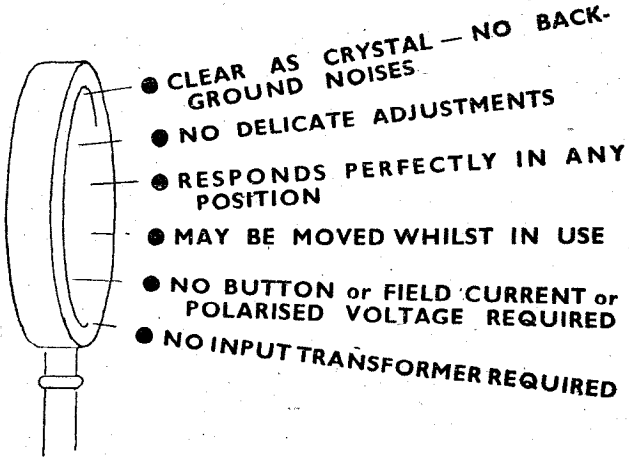

- CLEAR AS CRYSTAL — NO BACK-GROUND NOISES
- NO DELICATE ADJUSTMENTS
- RESPONDS PERFECTLY IN ANY POSITION
- MAY BE MOVED WHILST IN USE
- NO BUTTON or FIELD CURRENT or POLARISED VOLTAGE REQUIRED
- NO INPUT TRANSFORMER REQUIRED

*The most outstanding Microphone development of to-day!*

## PIEZO CRYSTAL MICROPHONE

TYPE D—104 DIAPHRAGM MODEL

**T**HIS Piezo crystal microphone is a particularly practical instrument. It has none of the inherent weaknesses of existing types and will give perfect response under all general uses. Most outstanding is the absence of any background noise—a crystal clear clarity being remarkably uniform throughout the whole range.

Absence of delicate adjustments means absence of repair bills. Being sturdy it can be moved around whilst in use and will respond perfectly in any position.

Cost of installation and operation are unusually low because it does not require button current, field current or polarising voltage. Neither is an input transformer necessary—the microphone being connected direct to grid.

The microphone is properly suspended and well protected inside a beautifully chromium plated housing—3 inch in diameter, 1 inch thick, complete with 6 feet of shielded cable.

Also suppliers of :—  
**"CENTRALAB" VOLUME CONTROL**  
 3/9. With switch 4/6

**"PIEZO" CRYSTAL PICK-UP**  
 with Bakelite arm,  
 Junior 26/- plus tax.  
 Senior 45/- plus tax.  
 Available in any quantities.

**PRICE £5 : 5 : 0**

**RADIO INTERNATIONAL PUBLICITY SERVICES LTD.**

**50 PORTLAND PLACE, LONDON, W.1.**

Phone : Langham 2000.

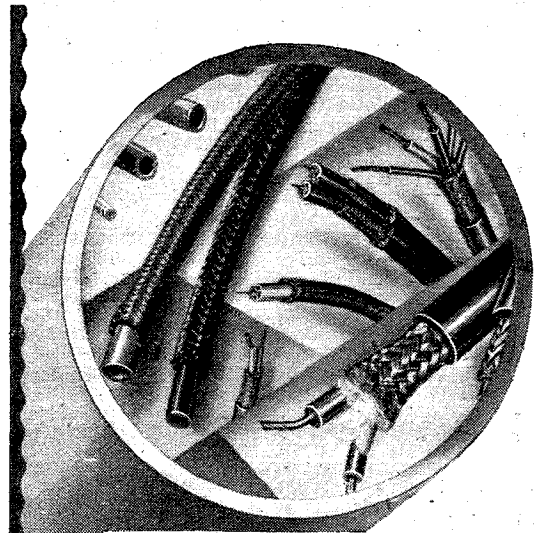

For electrical and chemical insulation the mechanical, physical and chemical properties of Tenaplas extruded plastics offer notable advantages over existing materials

# TENAPLAS

*Hand L* PRODUCTS

TENAPLAS LTD. Head Office: 7 PARK LANE, LONDON, W.1

## WHARFEDALE FACTORY SPEAKER

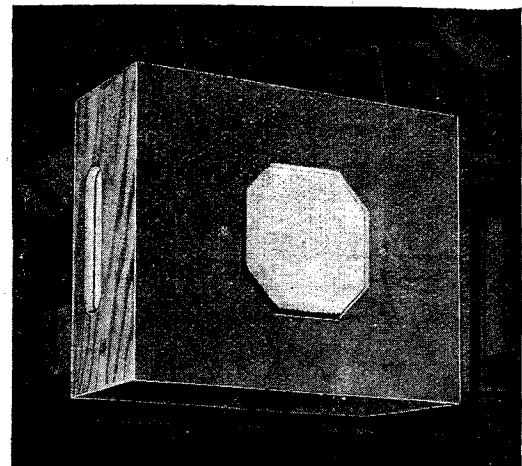

Available with or without Volume Control or Remote Control. REVERSIBLE. Fitted with 10" BRONZE UNIT for 5 Watts input.

## WHARFEDALE WIRELESS WORKS

SOLE PROPRIETOR: D. E. BRIGGS

HUTCHINSON LANE • BRIGHOUSE • YORKS

PHONE: BRIGHOUSE 50

GRAMS: "WHARFEDALE"



## LEADERSHIP

To radio technicians the name Mazda has always been synonymous with all that is progressive in valve development.

In design and performance MAZDA RADIO VALVES will always merit their title to leadership . . . the proud position they have held so long.

The Mazda Radio Valves logo, featuring the word "MAZDA" in a large, bold, sans-serif font with a 3D effect. Below it, the words "RADIO VALVES" are written in a smaller, bold, sans-serif font.

**MAZDA**  
RADIO  
VALVES



*Mazda Radio Valves are manufactured in Gt. Britain for the British Thomson-Houston Co. Ltd., London and Rugby, and distributed by*  
**THE EDISON SWAN ELECTRIC CO. LTD**  
**155 CHARING CROSS ROAD, LONDON, W.C.2**

*For full particulars write to Technical Sales Department.*

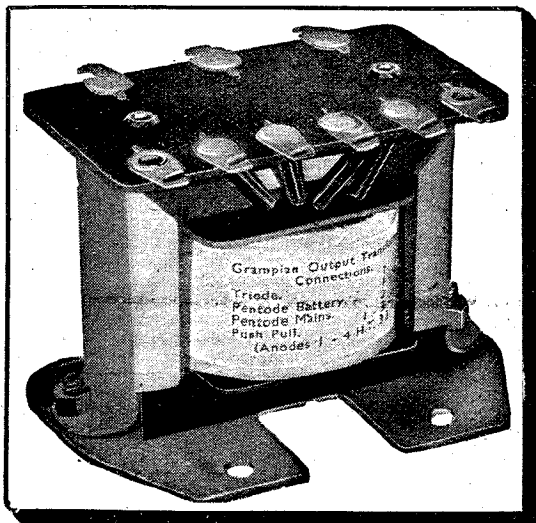

# QUICKER— AND BETTER THAN A RE-WIND

The New Grampian All-Ratio Output Transformer provides 8 Ratios to suit any standard speech coil impedance. Tapped primary and secondary ensure more exact matching than any other similar model. Primary is tapped for Triode, Battery Pentode, Mains Pentode and Push-Pull Output. Secondary is tapped for 2 ohms and 9 ohms speech coil. Universal fixing plate.

**HERE IS A PEDIGREE COMPONENT WHICH IS AVAILABLE AT LESS THAN RE-WIND COST.**

Owing to increased cost of material, we regret we were compelled to raise Price on 1st FEB. 1942 to **6'6**

CONVENIENTLY PACKED, FROM ALL FACTORS AND WHOLESALERS.

**GRAMPIAN REPRODUCERS LIMITED**  
KEW GARDENS, SURREY ————— Phone: RICHMOND 1175/6/7

## DR. CECILS RADIO CRYSTAL

improves reception on any crystal set.  
Send for Sample.

Post **1'6** FREE

**AUSTIN CLARKE (LONDON) LTD.**  
84, NEWMAN ST., LONDON, W.1.

## IN THE ORDINARY WAY

we could offer you Variable and Constant Voltage Transformers, Scott Groups, Swinging Chokes, Battery Chargers, etc., backed by all that is the best in service.

But these are not ordinary times, and demand exceeds supply in all things . . . except Service. That is freely at the disposal of our friends in the trade.

Let us know if we can help.

W. ANDREW **BRYCE** & CO. LTD.,

BOREHAM WOOD, HERTS

TELEPHONE: ELSTREE 1875

## LONDEX for RELAYS

For A.C. or D.C., silent and reliable

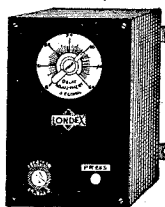

Synchronous Time Delay Relay PRL

2VA coil consumption, from 2-600 volts, tested to 2,000 volts. Unmounted and in cast iron casing. Also Time Lag Relays, High Sensitive Relays, Synchronous Process Timers, and Complete Control Plants.

Apply for leaflet SPN/WW.

**LONDEX LTD.**  
Manufacturers of Relays

Anerley Works, 207 Anerley Road, LONDON, S.E.20

Phone: SYDENHAM 6258 & 6259

## INSTRUMENT CASES AND CABINETS LABORATORY FITTINGS

APPARATUS CUPBOARDS AND RACKS

**SECTIONAL MASTS**  
(up to 50 feet high)

BASEBOARDS, FORMERS, DOWELS, ETC.

**All made from Seasoned Timber**

Supplied to individual and Trade requirements, singly or in quantity. Quotations upon receipt of details. No price list issued.

**R. SPEAKE & SONS LTD.**

Specialist Joinery Manufacturers

STAFFORD STREET

WOLVERHAMPTON

Contractors to various Government Depts. Phone: Wolverhampton 20429



# MOVING COIL MICROPHONES

In heavily nickel-plated cases. Impedance 25 ohms. Our stock of these high-class instruments is limited. As the demand for good quality microphones is rapidly increasing all orders will be executed in strict rotation.

Price **£4.5.0**

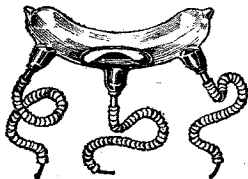
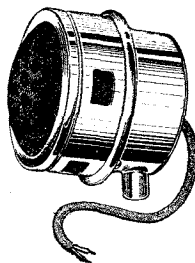

# MERCURY SWITCHES

Brand new finest mercury switches. Many hundreds of useful applications. Quick make and break, will carry 5 amps. Small quantity to clear at **8/6**

- **G.E.C. MOTORS**, 1/100th H.P., A.C. 225v. 50~ ... .. **47/6**
- **MILNES H.T. UNITS**, 120 volt Minors. CALLERS ONLY. ... Price **45/-**
- **CONVERTERS, D.C. to A.C.** 220v. D.C. input, 220v. A.C. output, 100 watts; enclosed in steel box, with suppressors, etc. ... .. **£15**
- **SINGLE R.A.F. EARPHONES**, resistance 750 ohms D.C. approx., 4/- each; ex-Govt. low-resistance single earphones, 2/6 each; microphone buttons, well-known make, 2/- each.
- **HEAVY DUTY DOUBLE BUTTON CARBON MICROPHONES**, chromium-plated case, gold-plated electrodes, high output, good quality, with mounting clips and springs, complete with transformer ... .. **23/6**
- **WESTINGHOUSE HEAVY DUTY RECTIFIER UNIT**, 6-8v. D.C. output at 32 amps., input 200-250 A.C., 50 cycle, size 22in. x 15in. x 17in. approx. Each **£30**
- **MAINS TRANSFORMERS**. Originally made for Television Power Packs where accuracy and robustness are essential. Weight 12lb., size 5½in. x 4½in. overall. 350-350v. 120 m.a. Tapped. 4v. 2a.; 4v. 8a.; 8v. 3a.; 20v. 1a. Diagram free. Post and packing 1/6 ... .. **25/-**
- **HEAVY DUTY MAINS TRANSFORMER**. Input 240v. A.C. One tapping at approx. 5,000v. max. 20 m.a., and one for supplying filament of Mullard HVR 2 (6.3v. at .65 amp.). Shrouded in metal box. Car. fwd. ... .. **10/6**  
Also input 200-250v. A.C., approx. 6,500 volts. Shrouded in metal box. Car. fwd. ... .. **20/-**
- **GOODMAN'S** 8in. P.M. Speakers, brand new, boxed, complete with universal transformer ... .. Each **22/6**
- **B.I. CONDENSERS**. 1 x 1 mfd. 7,000 volts D.C. test, with porcelain insulators **30/-**

# BATTERY CHARGERS

## 6-VOLT MODEL as illustrated

A further delivery of these well-made Heavy Duty Battery Chargers is just to hand. Built of first-class components with Metal Rectification and mounted on solid base board, as illustrated. Input 200/245 volts A.C. Output 1½ amps. at 6 v. Price **37/6** Each

## SMALL TRICKLE CHARGERS

These Chargers have metal rectification. Input 200-220v. A.C. Output 2v. ½ amp. Reliable and Shockproof ... .. Price **17/6**  
Similar to above, but in metal case for mounting ... .. Price **19/6**

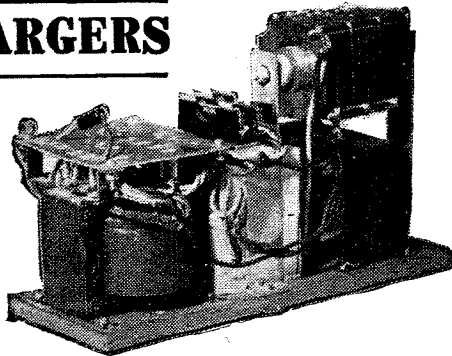

### PLEASE NOTE

Write your name and address in Block Capitals ● You should order only from current advertisement, as many lines soon go out of stock ● No orders can be sent C.O.D. ● Orders cannot be accepted from Eire or Northern Ireland ● Postage must be included with all orders.

# LONDON CENTRAL RADIO

## Opportunity Column

**TELEVISION DIODE VALVES**, unused Mullard EA50, 60 mm. x 12 mm., overall, 6.3v. heater at 15 amp.; 10/6 each.

**VALVES** are in short supply; stock of Mullard T.S.P. 4's and H.V.R. 2's to be cleared at 15/- each; first come, first served.

**CONDENSERS**.—Special offer of metal-cased paper condensers, 300v. working, all brand new and unused, 2 mfd. 2/-, 1 mfd. x 1 mfd. 1/9, 1 mfd. 1/9.

**VARIABLE CONDENSERS**, well made heavy 3-gang superhet condensers, die cast frames in first class condition; 5/6 each.

**FLESSEY SMALL BLOCK TYPE CONDENSERS**, two tappings. 0.0005 and 0.1 mfd., 350v. test; 1/- each. 10/6 doz.

### PUSH-PULL INPUT TRANSFORMERS

by well-known maker, nickel iron core, in metal case, size 2in. x 1½in. x 1½in. high, ratio 6 : 1. Price 6/6.

**TRIMMERS**.—Twin trimmers on ceramic base, brand new; to clear, 6d. each; 5/- doz. Also Bakelite Strip containing 5 Postage Stamp Trimmers, 2/6.

**TUBULAR WIRE-END CONDENSERS**, brand new, first quality components, 0.0003 mfd., 8d.; 0.005 mfd., 9d.; 0.01 mfd., 10d.; 0.1 mfd., 1/- each.

**ELECTROLYTIC TUBULAR CONDENSERS**, 25 mfd., 12v.; 25 mfd., 25v.; 50 mfd., 25v.; 50 mfd., 12v., 2/6 each. 5 mfd., 350v. D.C. working, 2/- each.

**COIL FORMERS**, cardboard and paxolin, assorted sizes, useful for experimenters; 1/6 doz.

**CHASSIS**.—Beautifully finished, highly polished, new cadmium-plated Chassis. Superbly made. 12in. x 8½in. x 3in. Drilled for 5 valves, transformer, etc. 4/- each. Also heavy gauge metal Chassis, finished battleship grey, 12in. x 5½in. x 2½in., 1/3 each. All drilled for valves, etc.

**ACCUMULATORS**.—Ediswan 2v. 60 amp. brand new in ebonite cases, size 8in. x 4½in. x 2½in.; callers only; 17/6 each.

**PLUGS AND JACKS** single circuit, new, 3/6 complete plugs only 2/- each.

**MORSE KEYS**.—Don't confuse these with inferior junk; it's a super job; 8/6 each.

**AUDAK CUTTING HEADS**, heavy duty type, 2-5 ohm coil, a really high-class instrument; 17/6.

**YAXLEY TYPE SWITCHES**, 2 bank 3-way, 2/-.

### DIMMING SLIDING RESISTANCES

carries 600 watts at 230 volts. Size 13½ in. x 4½ in. x 3½ in. Fully enclosed in strong metal ventilated case. Price 50/- each.

**OUTPUT TRANSFORMERS** primary 300 ohms D.C., secondary 0.5 ohm D.C., brand new, manufacturer's type, 5/6; also new chokes, 30 henry, 150 ohms, 5/- each.

**PHILIPS SPEECH TRANSFORMERS** for Pentode output; 3/6 each.

**ELECTRO-MAGNETIC COUNTERS**, resistance 500 ohms, from 1-12,999, size 4½in. x 2in. x 1½in., ex-G.P.O., invaluable for countless purposes, 9/6 each; a smaller type, 1-1,999, size 4½in. x 1½in. x 1½in., 5/6.

**VALVE HOLDERS**.—Belling-Lee special H.F. 5-pin chassis mounting in black bakelite; 1/- each, 10/6 doz.

**RELAYS**.—Small relays for operation on 2v. D.C. with 6-way make and break switches, brand new; 5/- each.

**FLEXIBLE DRIVES**, well made, shielded cable drives for remote control, ideal for gramophones, approx. 2ft. long; to clear, 4/- each.

**VOLUME CONTROLS** with switch, ½ meg. and ¼ meg., 6/6 each.

**MIDGET VOLUME CONTROLS**, 5,000 ohms, 3/6 each.

**VOLUME CONTROLS** with switch, 500,000 ohms, 1½in. spindle, 6/6 each.

# LONDON CENTRAL RADIO STORES

23, LISLE STREET, LONDON, W.C.2.

Telephone: GERard 2969.

# NEVILLE'S

COIL WINDING MACHINES

TAPING MACHINES

ARMATURE WINDERS

STATOR WINDERS

WIRE COVERING MACHINES

AND OTHER SPECIALISED  
MACHINERY FOR THE  
ELECTRICAL AND ALLIED  
INDUSTRIES

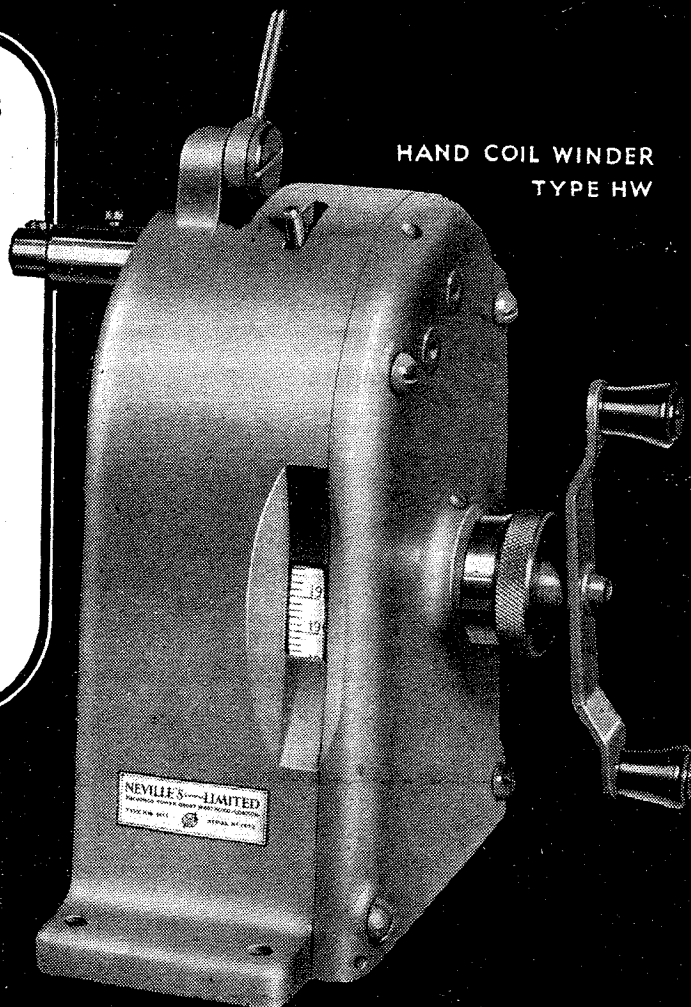

HAND COIL WINDER  
TYPE HW

## NEVILLE'S (LIVERPOOL) LIMITED

SIMMONDS TOWER · GREAT WEST ROAD · LONDON

Please address all enquiries to Western Office:  
City House, St. Stephen Street, Bristol, 1.

A DIVISION OF THE SIMMONDS GROUP

# Wireless World

Radio • Electronics • Electro-Acoustics

32nd YEAR OF PUBLICATION

APRIL 1942

Proprietors :  
ILIFFE & SONS LTD.

Managing Editor :  
HUGH S. POCOCK,  
M.I.E.E.

Editor :  
H. F. SMITH.

Editorial, Advertising  
and Publishing Offices :

DORSET HOUSE,  
STAMFORD STREET,  
LONDON, S.E.1.

Telephone:  
Waterloo 3333 (35 lines).  
Telegrams:  
"Ethaworld, Sedist, London."



**PUBLISHED  
MONTHLY**

Price : One Shilling

(Publication date 20th  
of preceding month)

Subscription Rate  
Home and Abroad  
13/- per annum

EDITORIAL ..	77
SHORT-WAVE DISTURBANCES. By T. W. Bennington ..	79
WHISTLING METEORS ..	82
INSTRUMENTS: TEST AND MEASURING GEAR AND ITS USES—II. By W. H. Cazaly ..	83
HOMODYNE RECEPTION ..	87
THE WORLD OF WIRELESS ..	90
NEWS IN ENGLISH FROM ABROAD ..	91
ELECTRONS IN U-H-F VALVES—II. By Martin Johnson, D.Sc. ..	92
ECKERSLEY REPLIES TO HIS CRITICS ..	96
D-F DEVELOPMENTS ..	97
UNBIASED. By Free Grid ..	98
LETTERS TO THE EDITOR ..	100
RANDOM RADIATIONS. By "Diallist" ..	102
RECENT INVENTIONS ..	104

Branch Offices :

COVENTRY:  
8-10, Corporation Street.  
Telephone: Coventry 5210.  
Telegrams: "Autocar, Coventry."

BIRMINGHAM:  
Guildhall Buildings,  
Navigation Street, 2.  
Telephone:  
Midland 2971 (5 lines).  
Telegrams:  
"Autopress, Birmingham."

MANCHESTER:  
260, Deansgate, 3.  
Telephone:  
Blackfriars 4412 (4 lines).  
Telegrams:  
"Iliffe, Manchester."  
GLASGOW:  
26B, Renfield Street, C.2.  
Telephone: Central 4857.  
Telegrams: "Iliffe, Glasgow."



As many of the circuits and apparatus described in these pages are covered by patents, readers are advised before making use of them, to satisfy themselves that they would not be infringing patents.

## WEARITE

### VIBRATORS for Dependable Power

Representing the result of several years research into Vibratory technique, they embody the most recent developments of both British and American Design and are manufactured in this country under "OAK Manufacturing Company's" Patents 460470, etc., etc.

Our technical staff will be pleased to co-operate in the solution of **your** Vibratory problems.

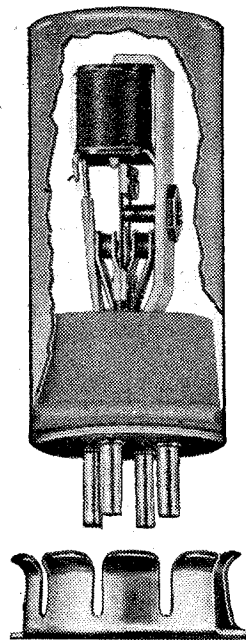

## WRIGHT & WEAIRE LTD.

HIGH ROAD, TOTTENHAM, N.17.

Telephones: Tottenham 3847-8-9

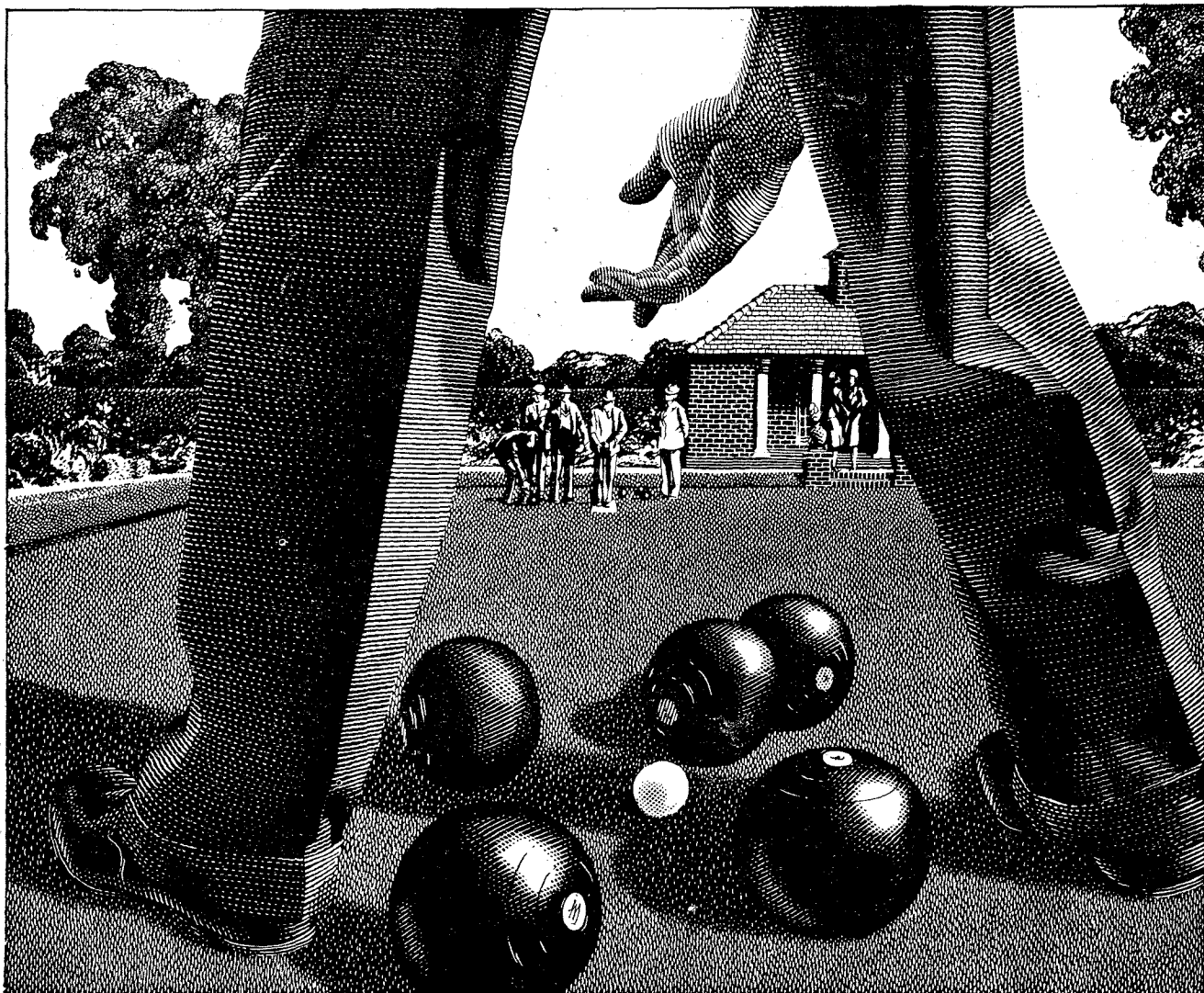

## *The Set Objective*

A hand beckons . . . the 'wood' describes a graceful arc and comes slowly to rest. With Mullard, too, the beckoning hand of world events shapes a course for progress to follow. And Mullard technical skill is

guided and directed towards that end. The new developments in electronic technique taking place in Mullard laboratories and factories today will determine the trend of manufacturing policy for years to come.

# **MULLARD**

## **THE MASTER VALVE**

TRANSMITTING AND RECEIVING VALVES FOR COMMUNICATIONS · BROADCASTING  
TELEVISION · SOUND AMPLIFICATION · ELECTRO - MEDICAL EQUIPMENT · INDUSTRIAL EQUIPMENT

THE MULLARD WIRELESS SERVICE CO. LTD.; CENTURY HOUSE, SHAFTESBURY AVENUE, LONDON, W.C.2

# Wireless World

Radio • Electronics • Electro-Acoustics

Vol. XLVIII. No. 4

APRIL 1942

Price One Shilling

## Broadcast Warfare

### *Intensifying Our Propaganda Effort*

TOWARDS the end of last year we supported on more than one occasion the plea for more imagination and spirit in the use of broadcasting—"the only brand-new weapon of this war"—as a vehicle of propaganda to enemy occupied countries. Although it would be an exaggeration to say that the plea for "fierce and stubborn resistance" to the spreading of the Nazi wireless net over Europe has been fully answered, there has been a steady strengthening of all the oversea services of the B.B.C., both technically and with regard to the matter broadcast.

Much interesting information on the general question of British propaganda broadcasting was given when the House of Commons debated in Committee a supplementary grant to the B.B.C. for the cost of its oversea services. The debate, which was not widely reported in the lay Press, made many valuable contributions to the question of how propaganda broadcasts should be composed. There seemed to be unanimity among those taking part in stressing the need for dignity and, above all, truth in the matter broadcast. It was emphasised that the B.B.C.'s reputation for veracity must be preserved and assiduously cultivated; nothing can do more to ensure a regular audience in a continent hungry for true news.

Among the many interesting matters that emerged from the debate was a suggestion that there is already too much broadcasting to any given audience. That is a view with which, in other contexts, we have often expressed sympathy. Bearing in mind the natural human limitations of those who prepare broadcast programmes, it is too much to expect that many hours daily can be filled with first-class material, especially when the audience is so difficult to please as that in enemy countries. Nothing is more likely to cultivate a regular listenership than the right kind of programmes. The objection that the audience is ever-changing does not

seem to be valid; all the more reason why the good material should be repeated rather than that the time should be filled with indifferent "padding."

Another suggestion to which almost everyone will subscribe was that special efforts should be made to give the enemy listener an opportunity of hearing news before he gets it through his own official channels. Everybody likes his news fresh, and will naturally turn to the station that gives it to him first. So valuable is a reputation in this respect that it might be worth while taking an occasional risk in order to acquire it.

### *Jamming British Broadcasts*

Turning to matters that are of more technical interest, Capt. Plugge gave some interesting facts on the establishment of jamming stations in France, about which he was consulted before her collapse. It was decided to build 80 100-watt jamming stations, each of which provided a small area in which German broadcasts could not be heard by the French. These stations have now been taken over by the Germans, and are used to jam British broadcasts to France. Naturally enough, the Minister of Information refused to answer a question as to what measures are being taken to counteract this jamming, nor would he be led into discussing Capt. Plugge's renewed suggestion for the erection of propaganda stations in Gibraltar, Malta and Cyprus.

Perhaps the most important matter discussed was the rebroadcasting of American programmes to Europe through B.B.C. channels. It appears that this excellent suggestion, made by Capt. Plugge last year, was shelved for a long time, perhaps because America was then neutral. The suggestion was renewed in January by the *Southern Daily Echo*, and the American rebroadcasting service was put into operation on February 1st. Here we have an

excellent example of the use of imagination in wireless warfare; if only for their novelty, the American broadcasts must appeal to many listeners on the Continent of Europe, and their transmission on normal wavelengths should ensure a wide audience. Let us have more of this kind of thing.

## B.B.C. Pronunciation

**N**OW that the war has become world-wide, it is high time that the B.B.C. dropped one of its affectations that must annoy countless thousands of listeners to news bulletins. We refer to the habit of announcers of pronouncing place-names in such a way that the average listener can hardly recognise them. The rule seems to be "when in doubt, pronounce the name foreign-fashion; the particular foreign inflection and pronunciation chosen does not matter much; the listener will not recognise it, anyway."

A good example of this confusing and entirely indefensible practice is "Bratsville," which often appears in the news. Why this town in Free French Africa should be pronounced Italian-fashion passes all understanding; at any rate, the announcers of the broadcasting station there seem quite satisfied with "Brazzaville," whether they are speaking in French or English. So many other examples within one's own limited knowledge come to mind that one is inclined to mistrust all the B.B.C. pronunciations.

There would be something to be said in favour of always giving place names their correct local pronunciation, but as the war spreads to little-known countries it would be practically impossible for the announcers to ascertain it within the time available. In any case, it would be necessary to spell out the word when its pronunciation differs widely from its accepted spelling.

There seems little need greatly to modify the suggestion that we made in pre-war days when the matter was of much less importance. We pleaded that place-names should be pronounced as by the more-than-usually well-travelled Englishman of good education. Such a man can generally be trusted to make a good compromise between pedantic accuracy and intelligibility.

Although Home news broadcasting is controlled by the Minister of Information, it is to be assumed that in the matter of pronunciation the B.B.C. is free from interference, and so must shoulder the responsibility for a practice that has endured far too long.

## Service-men's Qualifications

**I**N view of the present controversy on the question of training and professional qualifications of technicians, something may perhaps be learned from what has been done in the progressive Dominion of New Zealand with regard to service-men. For information on the subject we are indebted to a New Zealand airman now serving in this country.

It seems that in the Dominion no wireless firm is allowed to employ an unlicensed or unregistered service-man, except as an apprentice working under the supervision of a service-man who is duly registered. An applicant for registration must pass an examination in wireless theory and practice, after which he is required to gain experience for three years under a licensed service-man before being permitted to apply for a licence allowing him to work without supervision.

Particular emphasis is apparently laid, in the rules under which N.Z. service-men work, to the observance of safety regulations in installation work involving connection to the mains. The local supply authority inspects such work, and violation of the rules may involve prosecution, with possible cancellation of the service-man's certificate by the Radio and Electrical Traders' Federation, the body authorised by the Government to carry out wireless servicing examinations.

Such drastic control of the service-men's activities would, we imagine, be unpopular in this country. But, apart from the question of giving protection to the public, there is at least one point in favour of giving some thought to the possibilities of official control as a post-war measure. It would almost certainly tend to raise the status of the service-man, and to improve his conditions of employment. Apparently a more or less comparable system of registration for service-men, introduced in Denmark shortly before the war, had a beneficial effect.

## Fatal Shock

**B**ECAUSE service-men are scarce nowadays, many inexperienced persons are attempting to repair broken-down broadcast receivers, and several fatal cases of electric shock have been reported. It should be made widely known, both in the Press and by broadcasting, that all apparatus should be handled with respect. We are all apt to forget that a voltage of 700 RMS may often exist across the full secondary of a power transformer, while in quite unambitious equipment a peak inverse voltage of 1,000 may be found between anode and cathode of the rectifying valve.

Everyone knows that special care should be taken when working with apparatus in the vicinity of well-earthed objects such as water pipes. But they do not always realise that there are other nearby objects which may increase the risk of serious shock. For instance, it was recently reported that a soldier was killed through coming into contact with a heating radiator when repairing a broadcast set.

## Salvaging Accumulators

**A**N article on the regeneration of sulphated accumulator cells, published in *Wireless World* for December, 1941, seems to have caused some misunderstanding. The author of the article did not suggest that the improvement resulting from the treatment he described would necessarily be maintained indefinitely. Moreover, it was not suggested as a cure for troubles due to mechanical disintegration of the plates.

As the method is cheap, it could without any great risk be put forward as a possible means of salvaging accumulators so badly sulphated that they would otherwise be useless—an important consideration in these days of shortages. It would appear from the author's subsequent experience that in such circumstances the method is well justified. Asked for his comments, he writes, "With regard to the permanency of the improvement, this could only be established by experiments over a prolonged period, but so far as the writer's own experience goes, the eight accumulators described in the article have shown no deterioration over the past six months, although prior to the treatment they were practically useless. The treatment is not to be confused with methods advocated from time to time in which drastic chemical reagents are used, as in these cases loosening of the active material of the plates is almost inevitable."

# SHORT-WAVE DISTURBANCES

## Solar Phenomena That Affect Communication

By

T. W. BENNINGTON

IN the upper regions of the earth's atmosphere, radio waves advancing towards outer space alter the direction of their travel, curving round in a wide sweep so as to return again to the earth's surface. These regions are populated by myriads of ions and free electrons, which are brought into existence by the action of the sun upon the gas molecules of the atmosphere. The radio waves, on entering the region, set up motions among the ions, which motions comprise, in effect, an oscillating electric current. This current reacts upon the wave which produced it, so that its velocity is altered, and, instead of continuing onwards in a straight line, its direction of travel is gradually changed, so that eventually it is leaving the region again in the direction of the earth. For its path to be "bent" round so that this happens, a certain density of the ions is necessary.

The ionic density in the region undergoes various periodic changes, and, since it is the sun's rays which produce the ions, these changes are the result of variations in the amount of solar radiation affecting the region. There are, firstly, the diurnal and seasonal variations in ionic density due to the change in the zenithal angle of the sun. Another periodic variation is the rise and fall in the ion population brought about by changes that take place in the sun itself. These changes cause the radiations emitted from it to vary in a cyclic manner, with a maximum in intensity every 11 years. Since the behaviour of radio waves in the ionosphere—as the region is called—is so dependent upon the density of the ions and free electrons, it is evident that short-wave communication will be greatly influenced by these solar changes.

In connection with the periodic change in solar activity there occur from time to time great upheavals on the sun, from which extra radiation is emitted, so as to cause sudden changes in the ionic density in various parts of the ionosphere. This, as might be expected, gives rise to abnormal behaviour on the part of the radio waves, and to a condition often leading to their complete failure as a means of communication. The disturbances are of two distinct kinds, having, so far as their effect upon the radio waves is concerned, characteristics of a very different nature. One

of these is the "sudden ionosphere disturbance" and the other the "ionosphere storm."

**The Sun's Radiations.**—An enormous amount of energy is radiated into space by the sun as electromagnetic waves of many different wavelengths. The heat and light which we receive are among the longer wavelengths emitted, the waves of the visible light ranging from 7600 AU to 3900 AU<sup>1</sup>. A large range of shorter wavelengths is also radiated, though most of the "ultra violet" waves fail to reach the ground, being absorbed by the gases of the atmosphere. This is brought about by the waves setting the molecules of gas into a state of electrical oscillation, during which they dissipate energy which they receive from the waves. Molecules of different gases respond most readily to radiations of different wavelengths, and there is, in fact, a fairly sharp cut-off in the energy which does reach the ground at about 2900 AU, because at this wavelength there is heavy absorption by atmospheric ozone. Solar waves of shorter wavelengths are absorbed by other gases at different levels in the atmosphere. If there is strong radiation at the wavelength at which the molecules resonate, the oscillations may become so violent that the structure of the molecules is destroyed, and

<sup>1</sup>AU: Angstrom Unit. 1 AU=10<sup>-8</sup> cm.

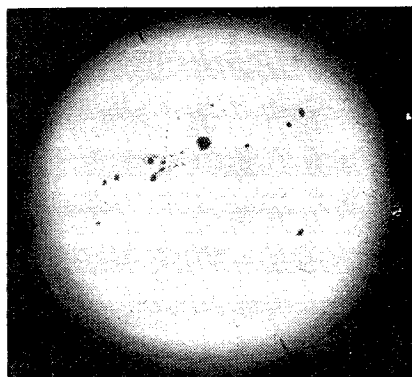

From "The Sun"  
The sun photographed at Mount Wilson  
on November 30th, 1929, showing  
groups of sunspots at a period of high  
solar activity.

thus the nature of the gas is altered. In this way, the actual *distribution* of the various gases in the higher atmosphere is affected by the radiations, and this fact accounts, in part, for the different character of the ionosphere at different times of day and year.

In addition to causing this dissociation among the molecules of gas the waves are also capable of ionising them, i.e., of causing electrons to part from the neutral atoms. This is the process that gives rise to the reflecting layers which guide radio waves round the earth. At the outer part of the atmosphere the main constituent is molecular nitrogen, and this is ionised by wavelengths of the shorter kind in the ultra-violet range, i.e., of the order of 850 AU. This produces the F<sub>2</sub> layer of the ionosphere, at a height of about 200 miles. Longer solar waves pass through this gas without losing an appreciable amount of energy, but further down they encounter other gases. At a height of about 60 miles molecular oxygen sets in, and quickly rises to high densities; this is ionised by waves of about 1100 AU, thus producing the stratified region of ionisation known as the E layer. At a height of about 38 miles there is a layer of ozone, and here a range of waves relatively near to those of the visible spectrum are absorbed. Dissociation of the ozone takes place, and a further region of ionisation known as the D layer is produced.

**Sunspots and Flocculi.**—The amount of solar energy reaching the atmosphere varies over an 11-year period because the activity of the sun, and hence its radiations into space, varies over that period. The best visible evidence of the variation in solar activity are the spots which appear on the surface of the sun (or photosphere). These sunspots are, in fact, huge vortices caused by eruptions within the body of the sun, from which matter is forced upwards into its atmosphere, which is known as the chromosphere. Additional radiation also comes from these areas, some of which can escape from the sun's atmosphere entirely, both in the form of particles of matter and also in the form of waves. The matter expelled from a disturbance can often be observed in the chromosphere as clouds of different gases, the clouds being usually more

**Short-wave Disturbances—**

dense in the vicinity of sunspots. They are known as flocculi, and are largely composed of hydrogen and calcium vapour, while their distribution in the chromosphere varies considerably according to the amount of solar activity prevailing.

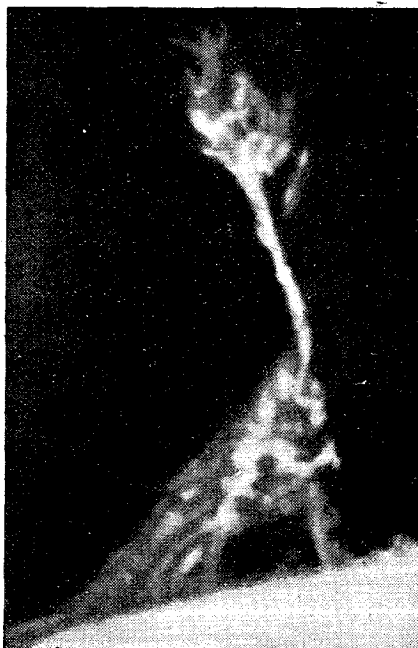

From "The Sun"  
An eruptive prominence on the sun's surface; its height is 450,000 km. above the sun's disc.

Both the sunspots and the flocculi thus show, by the marked change in their size and in the frequency of their appearance, that large variations in the degree of solar activity do occur, and that whilst there are large and erratic day-to-day changes, the activity does steadily increase and decrease, reaching a peak about every eleven years and with minima about half way between each of the maxima.

The shorter wavelengths appear to undergo the greatest change in intensity during the cycle. Perhaps fortunately for us, these waves never reach the ground, so there is at present no direct way of measuring their intensity or of telling how it varies. But now that "sounding" the ionosphere by means of radio waves has been developed; it is possible, by constantly recording the virtual height and critical frequency of the different layers, to obtain a measure of the ionising radiation which produced them, and also to follow its variations. It has been found that the critical frequency of the principal reflecting layer (i.e., the highest frequency returned

by it when the wave is sent up vertically) is about twice as great at the maximum of the solar cycle as it is at the minimum, and from this it would appear that the intensity of the ionising radiations must vary over the cycle by several hundred per cent.

In practical short-wave communication it is necessary to choose the working frequencies with regard to the ionisation level prevailing in the layers. If the ionisation is high, then, generally speaking, we must use only relatively high frequencies, because if we use low ones the waves will be too highly absorbed in the lower layers. If the ionisation is low, however, we must use relatively low frequencies because, otherwise, the waves will simply penetrate the layers, the ionisation being insufficient to "bend" the wave round so that it returns to earth. In other words, as both the refracting and absorbing power of the layers are proportional to the ionisation (in a particular layer) and inversely proportional to the frequency, higher frequencies must be used at the maximum of the cycle than at the minimum.

It is important to distinguish between the effect of the *general* increase in the sun's activity—which tends to improve short-wave conditions—and the effect of local disturbances which occur on and within it. These latter are now known to be the cause of the interruptions to short-wave communication which occur from time to time.

**Bright Solar Eruptions.**—Fairly frequently there occur eruptive disturbances on the sun from which are emitted not only huge quantities of gaseous matter, but also a large amount of energy in the form of wave radiations of various wavelengths, including those of visible light. They often take place in the vicinity of sunspots and if they occur on that side of the sun which is facing the earth and are of sufficient intensity, they produce certain terrestrial effects which occur only on the earth's sunlit hemisphere. The effects are produced no matter on what part of the visible disc of the sun the eruptions occur. Sometimes the gaseous matter which has been erupted is observable on a limb of the sun as a great "tongue" shooting out from the edge of the sun's disc, and it is then known as a "prominence." The radiations from the disturbances would appear to be sent out in all directions and, as the terrestrial effects start at the same time that the eruption is observed, they must be due to waves travelling at the speed of light. The eruptions usually last but a few minutes, though their terrestrial effects are still felt some

time after they have died down. The waves emitted would appear to consist largely of wavelengths relatively near to those of the visible part of the spectrum, and so able to penetrate the outer part of the atmosphere, where the gases are transparent to such waves. They do not, as far as is known, have any appreciable effect on the upper layers of the ionosphere. They continue on until at a height of about 38 miles they reach the ozone layer, where the waves are apparently absorbed, the absorption band for this gas including longer wavelengths than those for gases which are found in the higher atmosphere. Simultaneously with the arrival of the waves in the ozone layer, there appears an ionised region of very great intensity at the height of this layer, no doubt produced by the waves. The intensity of the ionisation continues to grow so long as the waves continue to arrive, but when the eruption dies down and the wave radiation ceases, the ions and electrons start to re-combine. Though they do this at a very rapid rate owing to the great density of the gas, an hour or more may elapse before normality is restored, owing to the great intensity of the ionisation which the waves produced in the first place.

**Sudden Ionosphere Disturbances.—**

Coincident with the time of observation of a bright solar eruption there is often a sudden cessation of all short-wave signals. This result of the eruption is known as a "sudden ionosphere

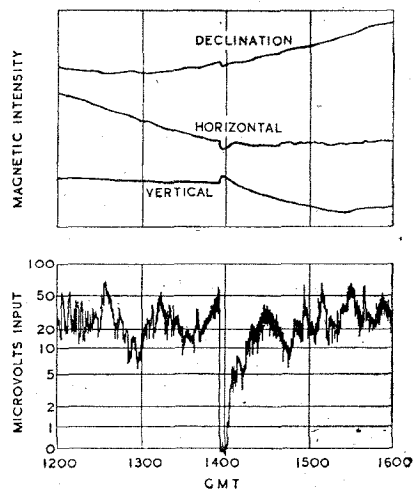

Sudden disturbance of the ionosphere on April 6th, 1936, as shown by fade-out of 13.525 Mc/s transmission from GLH, Dorchester, observed at Riverhead, New York, and (below) coincidental terrestrial magnetic perturbation recorded at Cheltenham, Maryland, U.S.A. Reproduced from "Sudden Disturbances of the Ionosphere," by J. H. Dellinger.



disturbance," and the correlation between the two phenomena is now conclusive.

The effect on short-wave reception is very impressive, for everything appears to go "dead," even the background noise disappearing. All frequencies within the short-wave range may be affected, though the disturbance is usually more intense and lasts longer on the lower frequencies. On the frequencies affected, signals usually fade away entirely within a minute or two, and may not return until anything up to two hours later, signal strength increasing from zero in a more gradual manner than that in which it was reduced. Only the sky waves are affected, and only those over transmission paths passing through the sunlit hemisphere. It has been found that on transmission paths which pass through low latitudes—where the sun's rays are more perpendicular—the disturbances are more intense than on paths which pass entirely through high latitudes.

The cause of the phenomenon is the sudden production of the intense layer of ionisation at the height of about 38 miles. The radio waves, on entering this region, set the ions in motion, with the result that they collide with neutral atoms. In so dense a region the number of collisions occurring is very great; and, as at each collision energy taken from the wave is expended, the result is such a heavy absorption of energy from the wave that it is often completely lost. The absorption is greater on low than on high frequencies, whilst it is greater in low than in high latitudes, because the ionisation produced is greater where the sun's radiations are most intense. For this reason transmission paths in the dark hemisphere are unaffected by the disturbance. When the ionising radiation ceases to arrive—after the eruption has died down—the electrons and ions start to recombine, and the absorption of the waves decreases. Owing to the density of the gas, the recombination rate is high; and, as the ionisation disappears, the short-wave signals come in again, the higher frequencies first.

Such disturbances are accompanied by a sudden brief fluctuation of the earth's magnetic field, caused by the sudden presence within it of large numbers of moving ions, whose movement is in reality a vast electric current carrying an associated magnetic field. This geomagnetic disturbance, like the ionosphere disturbance, is confined to the sunlit hemisphere, and is more intense in low than in high latitudes, and in these and other respects it is quite different in character from the "magnetic storm."

So also these sudden ionosphere disturbances are entirely different from the other type of interruption to which short-wave communication is subject, namely, the "ionosphere storm."

**Ionosphere Storms.**—The ionosphere storm constitutes the major form of disturbance to short-wave communication because, while usually its effect is not so intense as that of the sudden ionosphere disturbance, it is of much greater duration. During ionosphere storms short-wave signals on wavelengths normally well received drop to a very low level, and often disappear entirely. There is almost always a great increase in the amount of fading experienced, and a prevalence of the particular type known as flutter fading. The higher frequencies are most affected, and there is no discrimination between the sunlit and dark hemispheres. Transmission paths

of streams of particles from the sun, and that these corpuscles—which may be particles of ionised calcium—are shot out from disturbances which occur in the vicinity of sunspots. It may be that this is some of the vapour which is observed in the chromosphere after a bright solar eruption. Although part of this is known to fall back upon the sun, some of it appears to be forced outward by radiation pressure until it escapes from the sun's atmosphere. It would thus leave the sun at the same time as the wave radiation which produces the sudden ionosphere disturbances, but the corpuscles would travel much slower than the ultra-violet waves, and so would not reach the earth until some time later. Furthermore, while the wave radiation is emitted in all directions, and so reaches the earth irrespective of the position of the eruption on the visible disc of the sun, the corpuscular radiation seems to be in the form of a cone-shaped jet, with the eruption at its apex. So that, unless it is emitted from a position on the sun which is "pointing" more or less towards the earth, it misses this planet altogether. It has been noticed, for instance, that when a sudden ionosphere disturbance occurs as the result of a bright solar eruption near the central meridian of the sun, it is often followed—about 30 hours later—by an ionosphere storm, but that disturbances due to eruptions occurring in other parts of the sun are not followed by a storm. Apart from this, it is often noticed that when an ionosphere storm starts there is a sunspot in a position about 30 hours past the central meridian in the direction of rotation of the sun. So it would appear that if there is a disturbance on the sun near its central meridian—whether visible as a bright solar eruption or indicated by a sunspot—the corpuscles which are shot out do encounter the earth and produce an ionosphere storm about 30 hours after leaving. This would indicate that they had travelled through space at a speed of about 900 miles per second.

It should be added that the correlation between the start of ionosphere storms and the solar phenomena is not by any means perfect, some storms occurring when no eruption has been seen and when there is no spot near the central meridian, though there may be spots in other parts of the sun. This may be because the solar disturbance has not yet produced a visible sunspot, or because the corpuscles are not always emitted in a direction normal to the sun's surface. On the other hand, there is a definite tendency for storms to recur at intervals of about 27 days, corresponding roughly to the average rotation period of the sun,

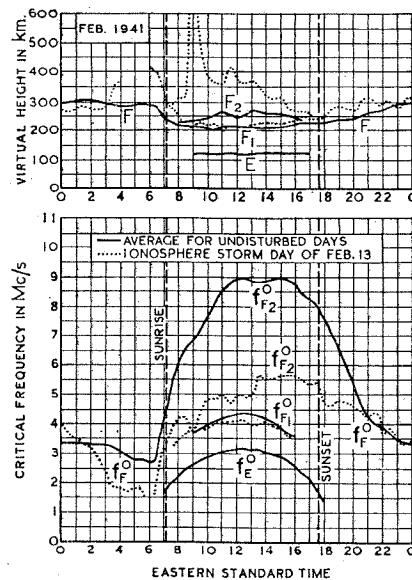

Courtesy, Proc. I.R.E., New York  
Virtual heights and critical frequencies  
of the ionospheric layers, observed at  
Washington in February, 1941, by the  
U.S. Bureau of Standards.

in low latitudes are less affected, however, than those passing through high latitudes, the paths most severely disturbed being those which pass through certain zones centred on the geomagnetic poles. Ionosphere measurements indicate that the principal effect is in the upper part of the ionosphere, and that the F layer is usually at an abnormally great height during the disturbance, and has an abnormally low ionisation density. The storms usually last for several days.

It is thought that disturbances of this type are caused by the emission

**Short Wave Disturbances—**

which would indicate that the same disturbance had produced an ionosphere storm during its successive passages across the sun's central meridian.

On reaching the earth's atmosphere the corpuscles are affected by the geomagnetic field, which carries them in the direction of the magnetic poles. Consequently, their effects, both upon the ionosphere and in other ways, are most intense in zones around the poles. A state of turbulence is set up in the ionosphere, particularly in the upper layer, leading to erratic conditions for the refraction of radio waves, with consequent abnormal fading. The F layer then appears to expand and to rise, and the stratification of the ions is upset. The ionisation per unit of volume is thus reduced, so that waves which are normally refracted begin to penetrate the layer. At the same time there appears to be an increase in absorption in the lower layers.

According to one observer of an exceptionally severe storm, the F layer continued to expand and to rise until it finally disappeared altogether, when an entirely new layer appeared lower down. This, in turn, expanded and increased in height until it, too, disappeared, to be followed again by another layer, the time between the appearance and disappearance of a layer being about three hours, the phenomenon becoming less and less evident until eventually the turbulence subsided.

Ionosphere storms have caused the *entire disappearance* of signals on certain frequencies in a few cases for as long as two days. Though not usually as intense as this, the average time for which conditions remain *subnormal* is between one and two days, whilst they have been known to remain so for nearly a fortnight. During the storms the highest frequency which the F layer will refract may be reduced by as much as 50 per cent. below normal.

**Magnetic Storms and Polar Auroræ.**

—Ionosphere storms are almost always accompanied by violent fluctuations in the geomagnetic field, which phenomenon is called a "magnetic storm." The fluctuations are rapid and irregular in character, and are quite different from the brief magnetic disturbance which occurs during a sudden ionosphere disturbance. Like the ionosphere storm, the magnetic storm occurs at the same time in all parts of the world, and is most intense in polar regions. Though the two phenomena are clearly connected, the start of the ionosphere and magnetic storm does not appear always to be exactly simultaneous, and the iono-

sphere storms usually persist for some time after the geomagnetic field has returned to a "quiet" state. Magnetic storms are caused by the abnormal movements of the ions in the atmosphere due to the action of the solar corpuscles, the movements of the ions constituting electric currents of great magnitude. These currents have associated magnetic fields which interfere with the normal geomagnetic field, and so produce the magnetic storm.

Another effect of the solar corpuscles is the production of the polar auroræ, which are intimately associated with variations in the geomagnetic field, and which occur frequently in the zones surrounding the magnetic poles where ionosphere and magnetic storms are of the greatest intensity. The coloured light of the auroræ is due to the emission of visible rays by atoms of atmospheric gas

when subjected to bombardment by the solar corpuscles. The height at which the auroræ occur has been measured, and it is thought that the lower limit of about 55 miles above the earth's surface represents the farthest distance that the corpuscles penetrate into the earth's atmosphere. Although the auroræ are usually confined to the zones around the magnetic poles, there are occasions when they are observed over much greater areas. The implication is that, under these conditions, the stream of solar corpuscles entering the atmosphere is of exceptional intensity, and such occurrences are almost always accompanied by ionosphere and magnetic storms of very great severity.

[The photographs on pp. 79 and 80 are reproduced from Giorgio Abetti's book "The Sun," by kind permission of the publishers, Messrs. Crosby, Lockwood and Son.]

## Whistling Meteors

### Newly Detected "Interference"

A RECENT paper<sup>1</sup> describes some interesting work carried out by the Research Department of All India Radio on a phenomenon which, as far as is known, has not previously been reported.

It was noticed that when listening to the unmodulated carrier waves of the Delhi short-wave transmitters at a location only 10 miles distant and therefore well within the skip distance for the sky wave, there were frequently audible heterodyne whistles of a peculiar type. These usually appeared as a high note of perhaps 3 kc/s frequency which rapidly descended in pitch, reaching zero frequency (or disappearing) from one-fifth to several seconds after first being heard. They are likened to the "ping" made by a rifle bullet deflected from a rock.

From this description it is easy to recognise the phenomenon, and it is probable that most radio men have heard it at one time or another without realising its special significance.

Ordinary heterodyne whistles are usually of a roughly constant pitch, or at any rate do not vary in frequency in this characteristic manner. It was realised by the A.I.R. engineers that these whistles must be due to interference between the directly received ground wave and a wave being reflected from a rapidly moving surface. Such a wave would suffer an apparent

change in frequency or Doppler effect, and it is this which, beating with the directly received ground wave, produces the heterodyne note. The descending pitch of the note is due to the moving reflecting surface being retarded in velocity down to zero.

The only likely phenomenon with a sufficiently high velocity to produce such Doppler effect is that of the meteors or "shooting stars" which enter the atmosphere, and the fact these were indeed responsible for the whistles was confirmed by observations of the appearance of meteors in the sky, their appearance coinciding with the whistles heard in the receiver.

The meteors apparently expend the greater part of their kinetic energy in ionising the molecules of atmospheric gas, the ionisation being caused by the energy of the impact of the molecule with the high-speed meteor. Such ionisation can be sufficient to reflect radio waves of the frequencies concerned, more particularly from the region at the head of the meteor.

By observing the initial frequency of the whistle it was possible to calculate the velocity of the meteor, and experiments showed that this was sometimes in the region of 60 km. per second, which agrees well with the figure obtained from visual observations. This and other experiments indicate that the whistle phenomenon will be of value in obtaining information on the conditions obtaining in the upper atmosphere.

<sup>1</sup> "Whistling Meteors—A Doppler Effect Produced by Meteors Entering the Ionosphere," by Chamanlal, M.Sc. and K. Venkataraman, M.A. *Electrotechnics* (Bangalore), November, 1941.

# INSTRUMENTS: *Test and Measuring Gear and its Uses*

By W. H. CAZALY

## II.—Output Meters and Attenuators

**F**IRST, it is necessary to make clear the meaning of the term "output." In the case of a receiver for sound reproduction, or of an AF amplifier, the output is conventionally taken to be the rate at which electrical energy is imparted to the speech coil of the loudspeaker or the windings of headphones. In other words it is an electrical power output which may be expressed in watts or milliwatts and measured by a form of AC wattmeter.

This way of estimating the output of a receiver or amplifier is simply a convenient convention. The true output consists, after all, of energy imparted to air by the motion of the diaphragm which is attached to the speech coil. This true output manifests itself in two ways; by physical movements of air particles and by heating effects. The reason why quantitative measurements of these two phenomena are not usually made or attempted, save for special purposes, is that they are difficult to carry out accurately and require rather expensive and elaborate apparatus. The human ear itself is, as a matter of fact, one form of "meter" responding to the true output. But it is incapable of precise and objective measurement, and serious errors are introduced, even with the best trained ears, by environmental conditions. It is possible to make measurements of the true sound output by systems of apparatus such as calibrated microphones and associated gear, with the speaker suspended in a space free of echo and acoustic resonance effects, but even then it is not easy to obtain anything but comparative data—and for the great majority of practical, everyday purposes data obtained under these special conditions are of little use because of the extremely variable and uncontrollable conditions under which speakers are normally employed. However, as a matter of interest, it may be mentioned that a few years ago<sup>1</sup> *Wireless World* inaugurated routine tests on these lines and published curves of various makes and models of loudspeaker.

We have normally, then, to take for granted the efficiency and fidelity with which a speaker converts the electrical

output of a receiver or amplifier into sound; performance measurement normally stops at the electrical output fed to the speech coil.

Now there are always at least three factors that have to be considered or understood when describing AC power phenomena. These are (a) the wave-form (fundamental and harmonic content); (b) the magnitude in volts or amperes; (c) the nature and magnitude of the impedance in which the power is being dissipated or used up. If these factors in the test input applied to a receiver or amplifier are accurately known, it is possible, by comparing the resultant measured output against this input to estimate the amount of gain, distortion, etc., brought about by the operation of the circuits between the input and output terminals.

### Test Routine

To make matters as simple as possible it is usual to employ a pure sine-wave voltage input of known amplitude when measuring performance involving output measurements. This is usually produced by a beat frequency oscillator, of which the frequency can be varied from 20 to 15,000 c/s; the amplitude of this voltage is monitored, so that it is kept always the same, by a valve voltmeter. To enable accurately known fractions of this constant voltage to be developed across the amplifier input terminals as may be required, an attenuator is used; and an output wattmeter records the electrical power fed to the speaker or dissipated in an impedance of equivalent magnitude.

The matter of the harmonic content of the output has to be dealt with by rather more complex gear. "Harmonic distortion" may perhaps be explained in very simple terms by saying that it consists essentially of the appearance in the output of frequencies that were not present in the input. They must have been put there somehow by the circuits handling the test signal.

There are two ways at least in which this sort of distortion can not only be made manifest (apart from the often unpleasant effect on the ear) but can actually be measured. One way is to

inject the output into a cathode-ray oscilloscope so that an actual picture of the wave-form appears on the screen; the picture can be copied accurately on to paper and analysed by mathematical process (Fourier's analysis) into the component sine-waves that make it up, the height and frequency of these component waves being thus ascertained and so the proportion they form of the total output. Another way lies in setting up sharply and accurately tuned filter circuits that separate the component waves and enable each one to be examined for amplitude and frequency on its own; these are called "harmonic filters" and are often quite complex, bulky and expensive pieces of apparatus. The oscilloscope is a very convenient modern instrument for ascertaining the harmonic content of the output of a receiver or amplifier, and is very commonly used for the purpose, but a description of it is outside the scope of this article; harmonic filters are far less commonly used, and then seldom outside a laboratory.

Now the output meter forms part of the impedance in which the output power is dissipated. It is necessary, therefore, if reliable results are to be obtained, that the output meter should either have so high an impedance that its shunting effect across the load impedance is negligible, or that it should provide, in conjunction with the load impedance, the correct output test impedance. Briefly, therefore, output meters may be classified into two types. In the first type to be considered the actual meter is a valve voltmeter, and this measures or records the voltage developed across a fixed known resistive output impedance that dissipates the output power in the form of heat; or it may consist of a low-impedance AC ammeter in series with the load impedance, measuring the current through that impedance.

The general principles involved are as follows. The power,  $W$ , dissipated in the load resistance  $R$  is given respectively by either  $W = I^2 R$  or  $W = \frac{V^2}{R}$ . Plainly, the value of  $R$  in ohms must be equal to the reactance in terms of ohms of the normal load

<sup>1</sup> March 29th, 1935.

**Instruments—**

impedance—the speaker speech coil, for instance—at the frequency employed during measurement. For this reason a multi-range output meter of this type may consist of a number of load resistances selected by a switch, across which, or in series with which, a valve voltmeter or an AC ammeter respectively may be connected on an appropriate voltage or current range.

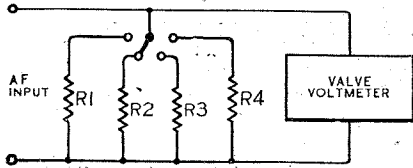
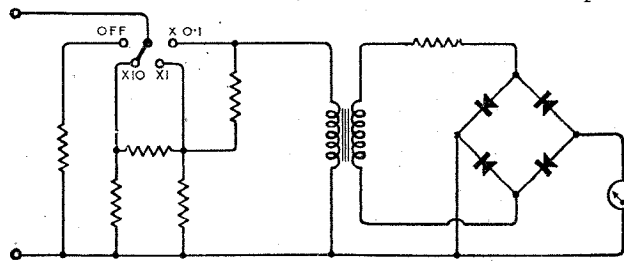
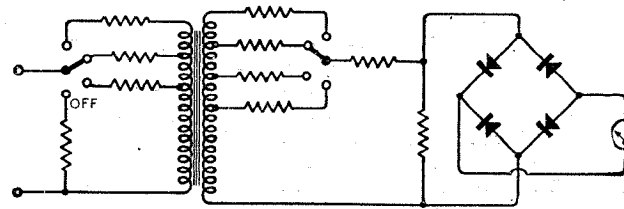

Fig. 1. A simple output meter. The resistances R1, R2, R3, R4 may be of ohmic values corresponding to the impedances of the various normal loads in the anode circuits of output stages, e.g., 2Ω and 8Ω to represent speech coils; 2,000Ω and 12,000Ω to represent primaries of speaker transformer. The valve voltmeter must be able to cover the ranges of voltage developed across these resistances.

For example, a quite useful form of output meter may be constructed on the lines of the circuit shown in Fig. 1 and the dial of the meter may be calibrated in terms of watts instead of in volts. Such meters, unfortunately, are not very sensitive and are not used much for measurements of lower power output of the order of less than a few milliwatts.



(a)



(b)

Fig. 2. In (a), the impedance of the instrument is constant, but the range of power measurement is variable. In (b) both the range of measurement and the impedance, for matching purposes, are adjustable. Note the "Off" switch position; a powerful output stage should always be loaded to avoid damage. No DC should be passed through the transformer windings.

The second type of meter to be considered makes use of the usual metal rectifier type of voltmeter and a transformer, the inductance of the primary of which makes it less independent of frequency than the former type. But it can be made sufficiently sensitive

to measure outputs of the order of microwatts.

Two practical forms are shown in Fig. 2 (a) and (b), which give skeleton circuits. If a number of receivers of the same type, requiring the same output load impedance, are to be tested, the impedance offered by the output meter and load resistance may be kept fixed, and various output ranges measured by making the load a resistive network offering approximately constant impedance at all settings of the range switch. Or, in a more versatile type, the input impedance as well as the range of the output meter may be altered to suit various receivers by tappings on the transformer primary and secondary.

For the sake of completeness it should be stated that the meter reading in rectifier-type instruments is proportional to the average value of the input wave form, and that errors may occur if the meter is calibrated with a sine wave and used subsequently on waveforms with a high harmonic content.

**Comparative Measurements**

The foregoing is a brief sketch of the sort of meter that can be used to make fairly accurate absolute power output measurements. These are usually expensive instruments, and for a great many purposes in the general run of service and test work only comparative data are required. For example, in an amplifier it is usually not so much the actual power

i.e., these two outputs have to be compared, and not exactly measured.

For such purposes the AC ranges of many types of general-service multi-range meters are quite suitable, and many of them are actually designed to be used in this way, as is shown in Fig. 3, which shows how an output meter may actually be connected to, say, the output stage of a domestic receiver for such purposes as observing resonance when lining up IF stages or taking audio-frequency response tests and so on. It must not be forgotten that a powerful output stage must never be operated on "no load"—i.e., with the speech-coil circuit completely open-circuited, otherwise peak voltages, especially at high AF, may seriously damage insulation. Either the output meter (representing

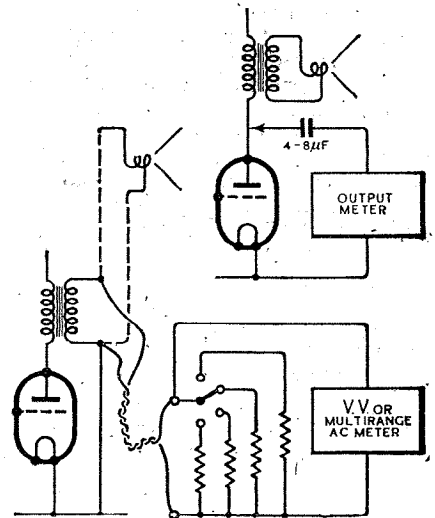

Fig. 3. The speech coil of the speaker may be left in circuit or replaced, as shown, by an equivalent resistance. If direct connection to the anode of the output valve is needed, it should be made through a good high-capacity paper condenser, not an electrolytic.

the speech coil) or the speech coil itself, must always be in circuit to provide a load.

For the benefit of those who, in these times, may find it difficult to obtain AC meters of any kind, the very simple arrangement is given in Fig. 4 of a 2-volt battery valve and an ordinary DC 5 mA meter with a few load resistances that may be used successfully for quite a number of comparative indications. This inexpensive little gadget is handy when aligning the RF and IF stages of a superhet receiver and even when taking rough frequency response curves in amplifiers. Since only comparative indications are noted, the dial of the meter is not altered from its original scale.

output that is interesting, but the levelness of the response of that amplifier to a wide range of frequencies. Thus, it is more useful to know, very often, that the output power for a constant input voltage is much the same at 100 c/s as it is at 2,000 c/s—

A triode valve of the HF or "Det" type will pass about 5 mA with applied AC of from 10 to 15 volts, and does not seriously shunt a low load resistance.

Attenuators, although not "instru-

ber of factors that add considerably to the complexities and difficulties of design of attenuators.

The "attenuator" of a simple and inexpensive service test oscillator—very rightly more often termed merely

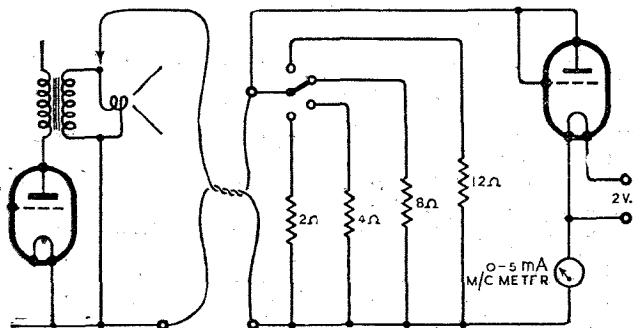

Fig. 4. For comparative indications it is seldom necessary even to disconnect the speech coil, the arrangement being as shown. The choice of load resistance is determined by the maker's figures for speech coil impedance, and/or the ratio of the speaker transformer.

ments" in the true sense of the term, are accessories of such value that they form a very important part of the outfit of a serious experimenter or tester. Their study covers a very wide and abstruse field, and in this article it is necessary to narrow it down to that portion containing the types of AC voltage attenuator of immediate practical use for RF or AF work.

The reason for their use and the source of their value is best understood by considering some practical example. How, for instance, is "one microvolt" measured, especially when it is at, say, 10 Mc/s? The answer is that it is not measured; it is "picked off," as it were, from a source developing an accurately measured 1 volt. The 1 volt across, say, 10 ohms, may be quite easily and accurately measured by some form of RF meter, either a valve voltmeter or a series thermo-couple arrangement.

The business of the attenuator is then to provide, across its output terminals, some known fraction of this original 1 volt. Were it DC that was being dealt with, the matter would be quite simple, but AC involves a num-

ber of factors that add considerably to the complexities and difficulties of design of attenuators. The "attenuator" of a simple and inexpensive service test oscillator—very rightly more often termed merely

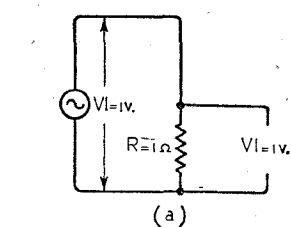
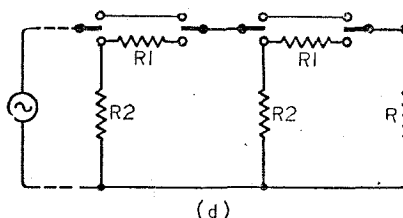
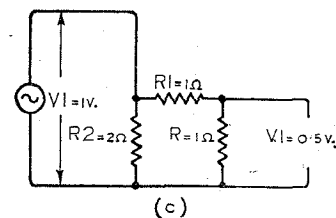
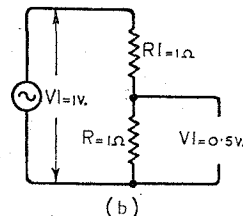

Fig. 6. Development of the "inverted L" attenuator. By means of the switches shown, any desired amount of attenuation can be obtained in steps. The dotted line indicates where other "L" cells may be added.



deal of general service work it is quite satisfactory. But it is practically useless for accurate quantitative measurements. It certainly "controls" the magnitude of the RF voltage appearing across the output terminals of the test oscillator, but not only is the absolute value of this voltage not known, but, unless the input impedance of the apparatus under test which is connected across the oscillator output terminals is extremely high, and so constitutes a negligible load, the frequency of the test oscillator is altered with every movement of the output control slider, owing to the "reflection" of the load across the coupling coil back into the tuned circuits of the oscillator.

What is wanted is something that

provides accurately known attenuation of the voltage across the coupling coil and presents, all the while it does so, a constant load on the oscillator tuned circuits, so that neither the frequency nor the magnitude of the voltage across the input terminals of the attenuator vary greatly with the amount of attenuation. This is commonly done by means of a "constant impedance RF voltage attenuator," which is not a very simple, and seldom an inexpensive, piece of apparatus.

The theory of such attenuators is dealt with in several books and has been discussed in *Wireless World*; the design problems are greatly simplified by standard formulae for various types, some of which have been reduced to the form of an abac in the *Wireless World* Radio Data Charts.

One of the simplest and most effective types is the "inverted L," the theory of which may be explained as follows. Referring to Fig. 6 (a), it will be assumed that 1 volt at 1 Mc/s is being developed across R, the terminating impedance (1 ohm). In Fig. 6 (b), R is in series with another re-

sistance R1 of 1 ohm, so that the voltage across R is now 0.5 volt, or half V, or "6 db down." But this, obviously, is not now presenting 1 ohm impedance towards the generator (valve oscillator), so that it is likely that the frequency of the oscillator will alter. However, if, as shown in Fig. 6 (c), another resistance R2 of 2 ohms is placed in parallel with R and R1, the attenuation of -6 db is still obtained, but the impedance of the network towards the oscillator is still 1 ohm as it was in Fig. 6 (a). This process, of adding "L" cells to the left of R, can be continued indefinitely, each cell adding -6 db attenuation without altering the load on, and therefore the frequency of, the oscillator. By calculation of the values of

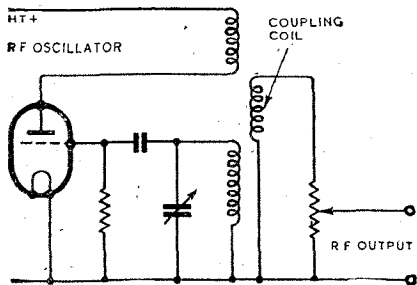

Fig. 5. This type of output control is used in several inexpensive test oscillators, and is satisfactory for rough general service work.

**Instruments—**the "series" and the "parallel" elements of the "L" cell, attenuation in steps of any required number of db can be secured.

It is common to construct attenuators to work in 10 db steps, to facili-

loose coupling between the attenuator and the oscillator tuned circuits, the effect on frequency of this change of load may be made negligible. The calculation of the values of the resistive components of this type of attenuator is not very difficult<sup>2</sup>; it starts

high frequencies, is rendered difficult and complex by the presence of stray capacities in addition to the resistance network, as shown in dotted line in Fig. 7. These cannot be completely eliminated, but they can be made small and their effects allowed for by

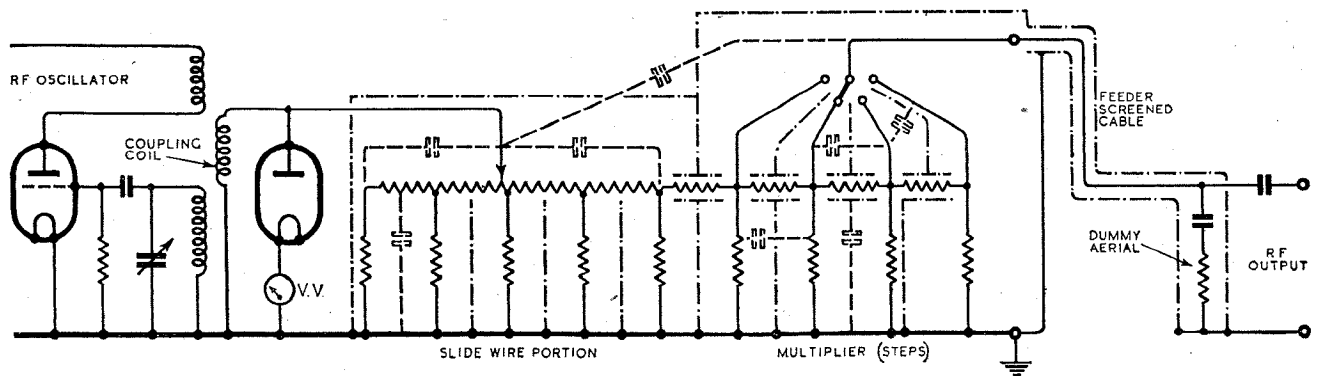

Fig. 7. Standard signal generator attenuator. The input voltage is monitored by a diode valve voltmeter. This voltage can be attenuated in steps by the "multiplier" and continuously varied in the "slide wire" potential divider. Some possible stray capacities are indicated, and also the elaborate screening required between elements.

tate measurements. Thus, such an attenuator with 8 steps, each of 10 db, would provide a voltage across the terminating impedance (R) —80 db down, or 1/100,000 of the voltage developed across the input terminals of the attenuator. Hence, if V were 1 volt, 10 microvolts would be obtained.

A quite common form of attenuator used in standard signal generators of the general-purpose type is that shown in Fig. 7. Here, the "coarse" control of output is effected by a network that attenuates the voltage by 10 db steps. For intermediate values, the voltage across the input terminals of this "multiplier" section is continuously varied by a plain slider arrangement. This is called a "ladder" attenuator, and is obviously not of constant impedance looked at from the oscillator. However, the ratio of change of attenuation to the change of load on the oscillator at various settings of the controls may be made high enough for any changes in frequency and departure from attenuator calibration figures to be practically negligible. Thus, such an attenuator may increase or decrease the voltage across the output terminals by as much as 100,000 times while making the corresponding increase or decrease of load provided by the attenuator on the oscillator only double or half, even at extreme ranges of attenuation. By low impedance

with the value of the terminating resistance and the amount of attenuation per step required. Since this terminating resistance has to be correct if the calibration of the attenuator is to be valid, standard and similar precision signal generators are normally provided with standard "dummy aeri-als" and standard feeder cables, which constitute this terminating impedance, and it is necessary that the circuit under test should be of high enough impedance to constitute a negligible shunt across this dummy aerial and feeder.

The construction of RF voltage attenuators, especially at the really

<sup>2</sup> See "Radio Laboratory Handbook," by M. G. Scroggie, "Measurements in Radio Engineering," by F. E. Terman, *Wireless World* "Radio Data Charts," by R. T. Beatty.

special mechanical constructions. For example, a well-known form of RF voltage attenuator consists of a heavy brass casting containing compartments for each resistance and, perhaps, moulded slider and switch parts; it is easier and cheaper to have a casting than to build up a complicated structure from sheet and tube metal. There are, of course, several other types of attenuator, but the ones thus briefly described are those most generally used in quantitative measurements on ordinary receivers. Their construction is comparatively simple, they can be designed to hold their calibration up to all but ultra-high frequencies, and they are mechanically well able to stand up to the hard use of routine testing.

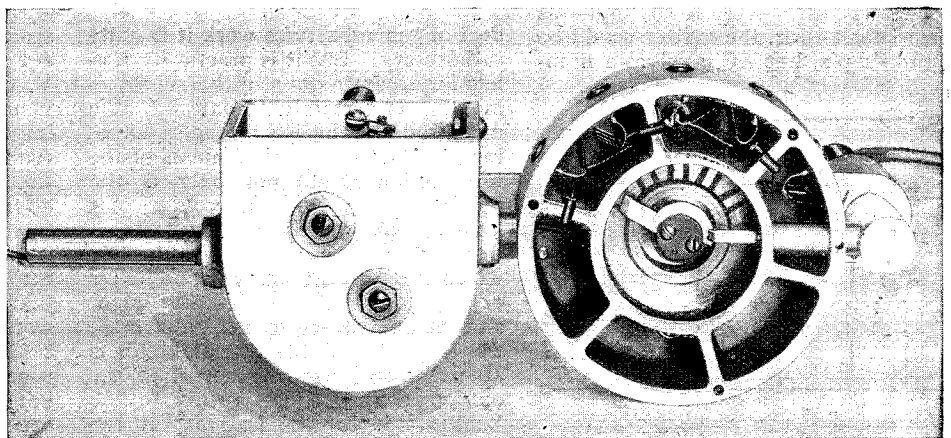

[Photo: Claude Lyons.

Attenuator and slide-wire assembly in the GR-603A standard signal generator, showing partitioned cast screening box.

# HOMODYNE RECEPTION

## Possibilities of the System as an Aid to Selectivity

THE "homodyne" system of reception is a little-known member of the family of radio "dynes," so let us first see how it is related to its cousins heterodyne, super (sonic) - heterodyne and autodyne. The word "dyne" is derived from the Greek for power, so that *heterodyne* merely means putting in energy at a *different* frequency, and becomes "supersonic-heterodyne" if the frequency difference is greater than audible (e.g. 465 kc/s), while *autodyne* means putting in its *own* power, i.e. a self-oscillating detector. Similarly, *homodyne* means that energy is put in at the *same* frequency, i.e. in synchronism with the carrier of the signal which it is desired to receive, and this is the system which may be able to help us with the selectivity problem.

Interference can be divided into two categories, the type which involves the carrier of the wanted signal, and the type which does not. In the first category we have the direct heterodyne between the wanted carrier and a neighbouring carrier, "side-band splash" which consists of heterodynes between the wanted carrier and the side-bands of the interfering signal, and cross-modulation; in all of these the output of interference is merely proportional to the weaker of the two frequencies which are beating together so that increasing the strength of the wanted carrier makes no difference to the interference. Before we can benefit from the homodyne principle, therefore, adjacent carriers must be spaced far enough apart for the heterodyne note to be outside the audio-frequency band, or alternatively the heterodyne must be eliminated by means of a "whistle filter" of some sort. The latter alternative is not the ideal solution, since it involves eliminating the same frequency (or rather a band of frequencies) from the programme; but if the filter has a narrow enough attenuation band, it may be a tolerable method. It seems likely to take a very long time to produce sufficient public demand for high-fidelity broadcasting on the medium-wave band to secure the sacrifice of a number of stations to adequate spacing of channels; in fact, it is a debatable point whether the introduction of wide-band U-H-F broadcasting would render superfluous high fidelity on the medium-wave

transmissions, or whether the experience of really good quality would lead to a demand for it on all transmissions. Assuming, however, that we have by some means eliminated the adjacent-channel heterodyne, and taken the necessary precautions against cross-modulation (which means practically building a receiver with RF stages that never overload), the residual interference will consist of the whole modulated signal (carrier plus side-bands) of a transmitter on a neighbouring frequency.

### Selectivity Limitations

There is an essential distinction between the wanted and unwanted signals, by reason of the fact that they have different carrier frequencies, and so it may be possible to eliminate the interference which consists solely of the independent signal more effectively than heterodynes, etc., which involve the carrier of the desired signal. But first one must answer the natural question, why not rely on selective circuits? Now, reasonable programme enjoyment requires a signal/interference ratio of 40 db., and for high-fidelity reception the ratio should be 60 db., i.e. a voltage ratio of 1000:1; add to this the condition that ideally one should be able to receive the weaker of two adjacent stations, say with a field-strength ratio of 10:1, and if the reader then thinks it is easy to design a receiver with adjacent-channel selectivity of 10,000:1, he need not worry about homodyne receivers.

Fig. 1.—Diode rectification with a strong "wanted" signal and weaker interference of different frequency. The diode conducts during parts of cycle shown shaded.

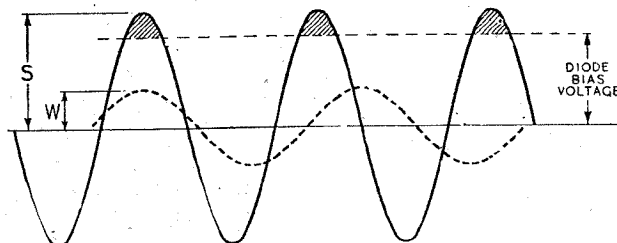

The phenomenon underlying homodyne reception actually occurs to some extent in every receiver using a linear rectifier; that is to say almost every modern receiver when a reasonably strong signal is tuned in; it is that a linear rectifier is most sensitive to signals in the same phase as the strongest signal out of several applied

to it. In the ordinary diode rectifier, the diode is automatically biased back by the signal so that it is only conducting for a small part of the cycle, say the extreme positive values of the voltage wave, as shown in Fig. 1. If now the amplitude of the signal is varied by modulation, there will be a change in the height of the voltage peaks, therefore an increase or decrease of diode conduction, and this in turn will change the bias voltage so that conduction occupies the same *proportion* of the whole cycle as it did for the original amplitude. But the bias voltage on the diode is in fact the rectified output, so that variation of this voltage with the input represents an output signal proportional to the amplitude modulation of the input signal.

### Detector Discrimination

Now suppose there is added to the input a smaller signal, at a different frequency, as suggested by the dotted curve in Fig. 1. The first positive peak of this second signal falls fairly well on the conduction period (determined mainly by the strong signal) and therefore increases the rectified current; but the second positive peak falls in a non-conducting period and therefore cannot affect the output, while the second conduction period is accompanied by a *negative* peak of the smaller signal, which reduces the rectified output and so tends to oppose the effect produced in the first conduction period. It is obvious that the weaker signal has relatively little

effect if of different frequency from the stronger one, since it is the latter which decides when the diode is conducting: as often as not the weaker signal comes up positive when the diode is thoroughly cut off by the stronger signal, and on those occasions when the diode is conducting, the weaker signal is as likely to be

### Homodyne Reception—

negative as positive. This is only a very rough picture of the action, because the frequency-difference is greatly exaggerated in Fig. 1, and no allowance is made for changes in duration of the conduction periods when the weak signal reaches a maximum or minimum near the edge of a conduction period; when it has been properly worked out mathematically, the ratio of the AF outputs due to modulation on the strong signal S and on the weak signal W is approximately  $2S^2/W^2$ , and the phenomenon is known as "the apparent demodulation of a weak signal by a strong one" (or, more briefly, "rectifier discrimination"). To see how useful this is, suppose that by means of selective circuits we have made the wanted station supply a carrier voltage 10 times greater than that of the unwanted station at the input to the detector: this represents a signal/interference ratio of 20 db., which would not be very good. But if  $S/W = 10$ , the ratio of the audio-frequency output voltages is  $2S^2/W^2 = 200$ , or 46 db., which is tolerably satisfactory.

### Selectivity and Tone Correction

In early receivers this gain from linear detection was not always obtained, because the signal level at the detector was so small that the detector did not function as an on/off device, as described in connection with Fig. 1, but as an approximately square-law device which conducted rather better in one direction than the other; since the stronger signal was thus not sufficient to stop conduction for part of the cycle, the weaker signal could always produce some effect, regardless of its phase relation to the stronger signal, and no rectifier discrimination was obtained. One of the first specialised systems to obtain this advantage (though the mechanism was not at first understood) was the "tone-correction" type of receiver. The RF circuits (including the IF, if any) were made of maximum Q, so that a very high gain was obtained at carrier frequency and low modulation frequencies, though the higher sidebands were relatively cut by a very large amount, and after detection the severe top cut was corrected by AF tone-correction circuits. Owing to the strong carrier, this gave good "rectifier discrimination," but the top boost in the AF circuits exaggerated any harmonics produced in the process of rectification or by asymmetry of the RF circuits: 2 per cent. to 5 per cent. of harmonics in the output of the detector could become something like 50 per cent. harmonics in the loud-

speaker, and the popularity of this system was short-lived. In fact, it died a natural death with the development of the superheterodyne and AVC; the latter required a large enough amplitude at the detector to ensure linear rectification, while the former provided the means of getting sufficient gain, and at the same time made it technically feasible to use selective band-pass circuits with a square-topped response, giving good adjacent-channel selectivity without requiring tone-correction.

But good tuned circuits are expensive and critical in adjustment, even when they work at a fixed intermediate frequency, and of recent years the number of high-powered transmitters has been greatly increased, so that once again selectivity is a problem. The tone-correction system was on the right track, but the top boost in the AF circuits was an intolerable nuisance; the solution then appears to be to increase the amplification of the carrier only, while retaining a uniform amplification for all the sidebands from lowest to highest, and this is the homodyne system. The three systems are represented diagrammatically in Fig. 2: diagram (a), normal receiver with square-topped response curve; (b), sharp circuits requiring subsequent tone-correction; and (c), homodyne receiver with carrier only accentuated. If wanted and unwanted signal reach the detector with equal amplitudes, the result will be a hopeless jam; but if we can add to the desired signal an artificial carrier of just over 30 times the existing carrier strength of either, we immediately obtain a rectifier discrimination  $2S^2/W^2$  equivalent

Fig. 2.—Homodyne reception compared with other methods of obtaining selectivity

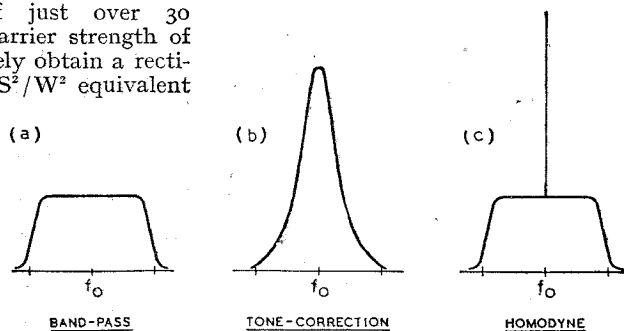

to 66db., and reception is perfect, without any disturbance of the audio-frequency response characteristic. In fact, the audio-frequency performance is improved, because an incidental advantage of the homodyne system is the elimination of one source of distortion in the detector. With a normal diode detector feeding a load circuit whose AC impedance is less than its DC resistance, distortion occurs when the depth of modulation exceeds some value such as 75 per cent. (depending upon the ratio of AC to DC load); when the carrier has been artificially

increased for homodyne reception, the depth of modulation will always be small, so that the ratio of AC to DC detector loads is no longer critical.

### Artificial Carrier

The problem, of course, is how to produce this artificial carrier, which must be exactly in phase with the original carrier of the wanted signal, and there are two main lines of attack. According to one method, the carrier is selected from the input by some form of filter, and amplified more than the sidebands. There are various methods of inserting the filter in the circuit, and a method of selective negative feedback has been suggested as suitable (Patent No. 533784, abstract published in *Wireless World*, Jan., 1942); but this does not go far towards solving the problem, for the filter still has to have a very narrow response, even if it is connected in the negative-feedback line instead of in a straightforward coupling between two stages of amplification. It can be assumed that the receiver is a superhet., and probably the IF will be 465 kc/s, while the lowest audio-frequency can be put at 50 c/s. (Any rise in the response to frequencies below 50 c/s can be easily offset by a falling-off in the characteristics of loudspeaker and AF amplifier.) The carrier-selecting filter must therefore have a band-width of not more than  $\pm 50$  c/s in 465 kc/s, which is a fairly difficult proposition even for a crystal filter. In addition, the intermediate

frequency must then be correct to something like 20 c/s, which means that both the accuracy of tuning and the stability of the local oscillator must be as good as 20 parts in a million for the higher-frequency end of the medium-wave band, and proportionately better for short-wave working.

The other line of attack is to use a local oscillator, somewhat similar to the IF beat oscillator used for CW reception, to generate the extra carrier voltage, and synchronise this oscillator with the signal carrier. Probably



most experimenters have done this at some time or another with a receiver using a reacting detector: if the reaction control is smooth enough, reception free from beat note can be obtained although the set is gently oscillating. But this is not really a fair example of homodyne reception, since it involves also a great increase of  $Q$  of the tuned circuit, and hence loss of high audio frequencies, which would not be present with a separate oscillator. In any case, this is hardly a method of reception to let loose on the general public. But granted the use of a superhet circuit and a separate oscillator valve for generating the carrier, which is then a practically constant frequency, there are possibilities in the way of designing the oscillator specially so as to hold synchronism over as wide a range of frequency as possible, though even so, tuning would need to be exceptionally accurate, and oscillator drift small. One of the troubles is that on 100 per cent. modulation the carrier of the signal to be received falls to zero, and the homodyne oscillator would then be almost certain to drop out of synchronism. (Some data on the effect of modulation on the synchronisation of an oscillator were published by Eccles and Byard in an article in *Wireless Engineer*, Jan., 1941, Vol. 18, p. 2.) Another snag is that the artificial carrier from the local oscillator would predominate in the output from the detector, so the DC component could not be used for AVC, which would have to be derived from an independent IF circuit free from carrier injection.

### Possibilities of Development

It is clear that a good deal of development would have to be done before a commercial broadcast receiver could be built on the homodyne principle. (Perhaps the problem might appeal to some of the amateurs whose transmitters are closed down "for the duration.") But the whole history of radio is the development of tricky laboratory apparatus into something approaching a foolproof piece of household equipment. For example, think back to the days of the earliest 1-v-2 receivers and compare them with the present-day superheterodyne. Instead of single-knob tuning and a dial engraved in kc/s, metres, and station names, one used to have two dials, marked only in degrees, which had to be simultaneously at the correct settings before any but the local station could be received. Instead of AVC to keep a constant output level, there used to be a reaction control, which usually needed progressive adjustment

as one tuned round the waveband; in order to keep a high level of sensitivity. Instead of independent volume and tone controls, there would probably be a reaction control supplemented by a rheostat in the filament of the RF valve to control gain, and the expert would balance reaction and gain adjustments to secure the desired volume and band-width. Looking at

this transformation of the radio receiver, and the parallel transformation of the television receiver from a 30-hole scanning disc in front of a neon lamp into the cathode-ray type of receiver, it does not seem unduly optimistic to say that the difficulties inherent in the homodyne system of reception could be overcome in a commercial design.

## "Mackay Radio Reports . . ."

**M**ANY readers will have noticed Press items beginning with the words written above without knowing of the interesting technical history of this concern. It began life in the U.S.A. as the Federal Telegraph Company in 1909, and had in operation communication services using continuous waves long before de Forest put the grid into Fleming's diode, so giving us the amplifying and oscillating valve. The company owes its success largely to the foresight of its founders who acquired the patents of Poulsen and Pedersen. The Poulsen system, as many people will be aware, used an arc for generating continuous oscillations, and it is interesting to note that the Poulsen arc transmitter

in its early days used FM, the frequency being shifted from one value to another by the transmitting key.

Prior to the Federal Company's enterprise, radio was used almost exclusively for communicating with ships at sea, point-to-point communication being employed only to a very limited extent largely because of the inability to cover long distances reliably, more especially in the daytime. CW altered all this, and in 1911 services were inaugurated connecting San Francisco with many other American cities, this service being extended to Honolulu the following year. To-day, of course, the valve has ousted the arc as a CW generator, and the company maintains point-to-point communication all over the world. Prior to the war, and, in fact, right up to the time America entered the war, several direct radio circuits were in operation linking Germany and other European countries with the U.S.A.

Mackay Radio was originally known as the International Telephone and Telegraph Corporation, and it was only when it took over the business of the Federal Telegraph Company that it assumed its present name. At that time, too, the valve was rapidly replacing the arc, with the result that the company was able to undertake a big expansion programme.

Apart from its point-to-point radio communication business, the company has a ship-to-shore service of considerable size. It is by means of its large network of coast stations that much of the information is collected with which we are so familiar in Mackay Radio news items. A special station is maintained in the middle of New York city to communicate with ships in the vicinity of the harbour.

In the interests of freedom from interference the company's transmitters follow the usual practice, and are situated in isolated spots, control being exercised from operating centres in the cities. It is noteworthy that nowadays very considerable use is made of the USW link instead of the ordinary landlines.



**BATTALION SIGNALLERS AT WORK.** This photograph, taken during recent exercises in Northern Ireland, shows a transmitting key strapped to the operator's thigh. It gives a tolerably good operating position and a more stable "platform" than might otherwise be obtainable in the field.

# THE WORLD OF WIRELESS

## U.S. RECEIVERS

ACCORDING to O. H. Caldwell, editor of our American contemporary, *Radio Retailing To-day*, an estimated total of 13,100,000 receivers were sold in the United States during 1941. These were valued at \$460,000,000. Of this total of receivers sold, approximately two million were car radio sets.

There is, of course, no licensing system in the U.S. from which the number of homes equipped with radio can be ascertained. It is, however, estimated that the approximate total is 30,300,000.

The number of receivers in use in the States is calculated at fifty-seven million.

It is perhaps noteworthy that whilst the sale of receivers during 1941 created a record, the total expenditure on sets was well below that of 1929 when the 4,500,000 sets sold were valued at \$600,000,000.

## WIRELESS ENGINEERING

SIR NOEL ASHBRIDGE, President of the Institution of Electrical Engineers, spoke of the changing character of the work of the Institution at a luncheon of the Transmission Section recently. One of the most valuable services rendered by the I.E.E., he said, was the directing of technical men into the most appropriate channels, particularly in the telecommunications and wireless services.

He stressed his view that wireless was quite definitely engineering, not merely a branch of physics, and that much benefit would result from greater staff interchanges between the lighter and heavier sections of the electrical industry.

## CANADIAN NEWS

THE manufacture of receivers for civilian use in Canada has, since January 31st, been prohibited except under special permit from the Munitions and Supplies Department. In January the production of receivers was limited to 50 per cent. of the average monthly output in 1940. The latest order is designed to "direct the productive facilities of the radio companies in increasing measure to the war effort."

Whereas the sale of receivers in the Eastern Provinces of Canada increased during the first nine months of 1941, the reverse was the case in the West. The number of sets sold was approxi-

mately 281,000, valued at \$15,913,597, compared with 274,300, valued at \$13,890,703, in the same period in 1940.

## CANADIAN BROADCASTING CORPORATION

MAJOR W. E. GLADSTONE MURRAY, General Manager of the C.B.C., deplored the lack of a high-power short-wave station for the dissemination of Canadian news in a recent address.

In reviewing the growth of the corporation Major Murray said that it had increased its effective coverage from 48.8 per cent. of the population in 1936 to 90.5 per cent. in 1940. Coverage is poorest in the Cariboo Valley of British Columbia.

Referring to the programme side, he said that commercial programmes accounted for approximately 16 per cent. of broadcasting time. There had, he said, been some apprehension that the Government controlled broadcasting system would be inferior to a commercial system, and that monopoly would bring "apathy, complacency and mediocrity." It was pointed out, however, that the Dominion's 46 privately owned independent stations and the commercial

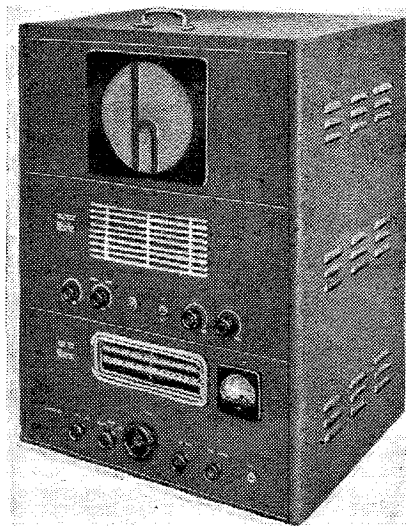

FM/AM RECEIVER. Hallicrafters' Model RSC-2 receiver, which is intended for hotel and hospital installations, comprises FM and AM tuners, a high-fidelity 25-watt amplifier, and monitoring speaker. Change-over from FM to AM is linked with the waveband switch. Provision is made for using a microphone and pick-up.

stations in the United States gave the necessary competitive urge.

## TELEVISION RELAY SYSTEM

AN extension of the radio-relay system of television between cities, which is already working between New York and Philadelphia, is planned by executives of four American television companies. It is planned to erect a station in Washington and to link it with Philadelphia.

It is learned from *Broadcasting* that this scheme is in place of the original plan of RCA-NBC to establish its own network along the eastern seaboard. The proposed scheme will be joined by N.B.C., Du Mont, General Electric and Philco.

## VALVES FOR SOUND APPARATUS

THE supply of valves for cinema sound apparatus has been under consideration by the Cinematograph Exhibitors' Association for some time. The British Radio Valve Manufacturers' Association has requested members of the C.E.A. to place orders at once for the valves they are likely to require during the current year to ensure as far as possible a supply.

It is stated that rectifying valves of the hot-cathode type will probably be unobtainable, and facilities are, therefore, being made for the supply of alternative types of rectifiers.

## N.B.C. NETWORKS

IN anticipation of the U.S. Federal Communications Commission's much-talked-of chain-monopoly regulations, which are to forbid the ownership of more than one network of stations by any one concern, the National Broadcasting Company is arranging for the separation of its "Blue" and "Red" networks.

It is planned to form a separate concern, which may be known as the United Broadcasting System, to operate the Blue network. U.B.S. would be a subsidiary of R.C.A., as is N.B.C.

The Blue network stretches from the Atlantic to the Pacific coast and includes more than 150 stations.

## WGY SCHENECTADY

IN recording the twentieth anniversary of the opening of the General Electric medium-wave station WGY, situated at Schenectady, New York, our American contemporary, *Communications*, details some of the outstanding developments in its history.

It was as early as 1923, one year after its opening, that the station used metal water-cooled modulator valves, and the condenser microphone. WGY claims to be the first station to make use of both of these advances. Two years later crystal control of the transmitter frequency was introduced.

**C.B.S. LONDON CHIEF**

**EDWARD R. MURROW**, Chief of the Columbia Broadcasting System's European staff, is in the United States on his first furlough from London for three years. At a dinner given in his honour by the President of the C.B.S., which was attended by over 1,000 guests, a telegram from President Roosevelt was received; it read: "You of C.B.S., who gather to-night to honour Ed. Murrow, repay but a tiny fraction of the debt owed him by millions of Americans and people who live in other lands where it still is not a criminal offence to listen to or to read news reports."

**Holiday Employment Wanted**

The National Union of Students, of 3, King's Parade, Cambridge, would like to hear from any wireless firms which can offer temporary work to one or more students during the Christmas, Easter or Summer vacations. Letters should be addressed to the Hon. Secretary of the Engineering Committee.

**Archaic Wireless Practice**

The Radio Component Manufacturers' Federation states that some sections of the wireless industry still order components in terms of the gross. This practice involves unnecessary calculations and is archaic. It is hoped that in future orders will be in multiples of 100.

**Broadcasting and Fuel Economy**

As a result of investigations carried out upon the recommendation of the Select Committee on National Expenditure, it has been shown that only a very small saving in fuel would be effected by reducing the number of hours of broadcasting. If the B.B.C. transmitters closed down at 10.30 the saving in coal consumption, it is estimated, would be just over 0.5 per cent. of the total consumed in the November-March period.

**B.B.C. English Bulletins**

Of the ninety-seven news bulletins broadcast each day in forty languages in the B.B.C.'s Oversea Services, the following are in English. The times are BST—one hour ahead of GMT.

- 0200: 31.32, 30.53, 25.53.
- 0345: 49.10, 31.32, 30.53, 25.53.
- 0530: 49.10, 31.32, 25.53.
- 0715: 42.46, 31.55, 31.25, 25.53, 19.82.
- 0900: 49.59, 48.43, 42.46, 41.49, 31.55, 25.53, 25.29, 24.92, 19.82, 19.60, 19.51, 19.42, 16.84.
- 1200: 31.25, 25.53, 19.82, 16.84, 16.77, 16.64, 13.97.
- 1400: 25.53, 19.82, 16.84, 16.77, 16.64, 13.97.
- 1700: 31.55, 19.82, 19.66, 19.51, 16.84, 16.77.
- 1900: 25.68, 25.53, 19.82, 19.66, 16.84, 16.77.
- 2145: 31.25, 25.68, 25.53, 25.38, 19.82.
- 2215: 31.32, 30.53, 25.53.
- 2300: 49.59, 41.96, 41.49.
- 2345: 31.32, 30.53, 25.53.

**FM Car Radio**

WHAT is believed to be the first frequency-modulated receiver for installation in a car has been built by Radio Engineering Laboratories, of Long Island City, New York. The receiver, which has been built for the general manager of the Milwaukee FM station W55M, is fixed tuned by crystal control to the station's frequency. A quarter-wave telescopic aerial is carried, and the control unit includes a signal strength meter.

**I.E.E. Meetings**

A PAPER on the technique of frequency measurement and its applications to telecommunications will be given by J. E. Thwaites and F. J. M. Laver before the Wireless Section of the Institution of Electrical Engineers on Wednesday, April 1st. Distortionless detection will be the subject discussed at the informal meeting of the Section on Tuesday, April 14th. Dr. O. E. Buckley will deliver the 33rd Kelvin lecture on the future of transoceanic telephony at an ordinary meeting of the Institution on Thursday, April 23rd. All meetings will begin at 6 o'clock.

**Brit. I.R.E.**

At a meeting of the British Institution of Radio Engineers on Saturday, April 18th, Capt. P. P. Eckersley will give a paper on "Future Development in Radio Communication." The meeting will be held at the Federation of British Industries, 21, Tothill Street, London, S.W.1, and will begin at 3 o'clock.

**R.S.G.B. Meeting**

A MEETING of the Radio Society of Great Britain has been arranged for Saturday, March 28th, at 2.30 p.m., when D. N. Corfield, G5CD, will talk on concentric-line tuned circuits. It will be held at the Institution of Electrical Engineers, Savoy Place, London, W.C.2.

**IN BRIEF**

**U.S. Bans New Sets**

THE U.S. War Production Board has ordered that the manufacture of broadcast receivers and gramophones for civilian use must be discontinued after April 22nd.

**Radio Officers**

A RADIO Officers' Panel has been added to the National Maritime Board so that this important branch of the Merchant Navy will in future be represented when orders affecting the Service are discussed by the Board.

**NEWS IN ENGLISH FROM ABROAD**

**REGULAR SHORT-WAVE TRANSMISSIONS**

Country : Station	Mc/s	Metres	Daily Bulletins (BST)	Country : Station	Mc/s	Metres	Daily Bulletins (BST)
<b>America</b>				<b>India</b>			
WNBI (Bound Brook)	11.890	25.23	7.0 a.m., 10.45 a.m.	VUD4 (Delhi) .. ..	9.590	31.28	9.0 a.m., 1.30, 4.50.
WNBI .. .. .	17.780	16.87	3.0†, 4.0†, 6.0.	VUD3 .. .. .	11.830	25.36	1.30.
WRCA (Bound Brook)	15.150	19.80	3.0†, 4.0†, 6.0.	VUD3 .. .. .	15.290	19.62	9.0 a.m.
WGEO (Schenectady)	9.530	31.48	9.45 a.m., 9.0†, 10.55§†.	<b>Sweden</b>			
WGEA (Schenectady)	15.330	19.57	2.15, 7.45§†, 9.55§†.	SBO (Motala) .. ..	6.065	49.46	10.20.
WGEA .. .. .	9.550	31.41	9.45 a.m.	<b>Turkey</b>			
WBOS (Hall) .. ..	11.870	25.27	12.45 a.m. (Mon. Ex.), 12.0 midt.	TAP (Ankara) .. ..	9.465	31.70	8.15.
WBOS .. .. .	15.210	19.72	3.0†, 4.0†, 6.0.	<b>U.S.S.R.</b>			
WCAB (Philadelphia)	6.060	49.50	2.55 a.m., 6.0 a.m.	Moscow .. .. .	6.977	43.00	12.0 noon, 6.0, 8.0, 9.30, 10.45.
WGBX (Wayne) .. ..	11.830	25.36	7.30†, 8.15†, 8.45§†, 11.30.	<b>Vatican City</b>			
WGBX .. .. .	15.270	19.65	2.0, 5.0§†.	HVJ .. .. .	6.190	48.47	8.15.
WRUL (Boston) .. ..	9.700	30.93	12.15 a.m.†.				
WRUL .. .. .	11.730	25.58	12.15 a.m.†.				
WRUL .. .. .	11.790	25.45	9.30†, 11.30§†.				
WRUL .. .. .	15.350	19.54	5.0*, 9.30†, 11.30§†.				
WRUL .. .. .	17.750	16.90	5.0*.				
WLWO (Cincinnati) ..	15.250	19.67	7 a.m., 6.0†, 7.0†.				
<b>French Equatorial Africa</b>							
FZI (Brazzaville) .. ..	11.970	25.06	8.45.	<b>MEDIUM-WAVE TRANSMISSIONS</b>			
					kc/s	Metres	
				<b>Ireland</b>			
				Radio Eireann .. ..	565	531	1.40†, 6.45, 10.9.

It should be noted that the times are BST—one hour ahead of GMT—and are p.m. unless otherwise stated. The times of the transmission of news in English in the B.B.C. Short-wave Service are given at the top of the page.

\* Saturdays only. § Saturdays excepted. † Sundays only. ‡ Sundays excepted.

# ELECTRONS IN U-H-F VALVES

## II. Hollow Resonators and Circuits of High "Q"

WHEN any periodic EMF is applied in one region of any extended conductor, a wave may be propagated from that region in accordance with the electrodynamic laws embodied in Maxwell's equations. The configuration of the electric and magnetic fields, and the speed of propagation, depend slightly on the materials of the conductor but mainly on those of its neighbouring dielectric; the constants of both appear if a full solution of the equations is written down, and are important in determining the losses.

This is an extremely general proposition. According to the form and the materials used, the lines of electric and magnetic force may either break away, carrying energy into space, build up a stationary system, or transfer power to some further conducting system. In other words, we may have a radiating antenna, a resonator, or a matched link in a transmission line. Thus aerials and feeders, the almost universal devices of ordinary radio, need only certain modifications under this general law to become the less familiar closed resonators of modern U-H-F engineering.

The form of any extended conductor mainly decides whether it acts as a good resonator or aerial or transmission line, and it is in terms of various impedances that it will be judged. Further, it is the application of such familiar concepts as capacitative and inductive reactance to unfamiliar structures that presents the chief difficulty in understanding U-H-F devices. If we accept the well-known laws for the impedance of inductances and capacities in series and in parallel on the assumption that they are localised as coils and condensers, it is not difficult to imagine their defects at extreme frequency. On the practical side, if we attempt to use conventional components the actual apparatus becomes unmanageably small, it has severe radiation losses, presents too small a surface for "skin" conductance, and in general cannot handle power.

It is a logical step to think next of the voltage-current relations of any system which transmits power at any frequency in terms of  $L$  and  $C$  "distributed" equivalently along the whole system instead of "lumped" into coils and condensers. In this way the "equivalent" impedances of a radio

By  
MARTIN JOHNSON, D.Sc.

**In the first part of this article, the question of transit time was discussed, and examples were given of specially designed valves in which velocity modulation is used to convert DC energy into U-H-F impulses. This instalment deals with the resonators forming the tuned circuits generally used in association with these valves.**

antenna or of a telephone cable become the essential parameters deciding its utility as storage reservoir or as distributor of power.

One particular impedance is especially useful; this "characteristic impedance," often called "surge impedance," written  $Z_0$ , can be defined in more than one way. For the present needs it may be considered as denoting the impedance with which any conducting line must be terminated if the propagated wave is not to be reflected back when it reaches the far end.

$$Z_0 = \sqrt{\frac{R + j\omega L}{G + j\omega C}}$$

$R$  and  $G$  are resistance and conductance per unit length and  $j$  is the

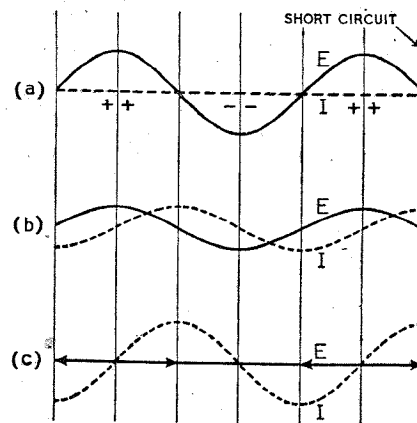

Fig. 1. Instantaneous space-variation of potential (full-line) and current (dotted line) in a short-circuited transmission line. (b) is at an instant  $\frac{1}{4}$  cycle later than (a), and (c) is  $\frac{1}{2}$  cycle later than (a). Instantaneous directions of currents are shown by arrows, and charges by + and - signs.

usual symbol  $\sqrt{-1}$ . The simpler expression which we shall need for resonators,  $(L/C)^{\frac{1}{2}}$ , is obviously valid only if  $\omega$ , the angular expression of frequency, is sufficiently large.

**Stationary Waves.**—If any transmission line is not terminated in a load of impedance equal to its  $Z_0$ , there is a discontinuity in the flow of energy and the boundary conditions for the equations of the electromagnetic field show that some reflection of the waves must occur. In the extreme cases where the line is either open-circuited or short-circuited the coefficient of reflection may be as great as unity so that a backward wave train combines with the forward to form a set of standing waves. These have some analogy to the stationary waves of sound in organ pipes, antinodes of maximum voltage amplitude being separated by distances of half a wavelength, as are the rarefactions or compressions of the longitudinal vibrations of sound.

In Fig. 1 we show three instantaneous pictures of the space-variation of voltage and current along a transmission line short-circuited at the right-hand end. At the moment when all the energy is in the electrostatic form the current is everywhere zero. A quarter of a cycle later, when the phasing has progressed by  $\pi/2$  or 90 deg., the voltage in turn is zero and the energy is in the magnetic field. Between these time intervals, for instance, as shown in Fig. 1 (b), both current and voltage appear, 90 deg. apart, but with amplitudes a fraction of their maxima. If at the right-hand side of the picture there were an open circuit instead of a short, the reflections would occur at potential antinodes and current nodes, instead of at potential nodes and current antinodes, but there would still be a stationary pattern of waves. In these, and in the more usual pictures which in text-books are hard to interpret because they illustrate more than one thing at once, it is important to realise that what is being shown is the spatial variation.

If, in contrast, the line does feed into a load of  $Z_0$  instead of into short or open circuit, no reflection or stationary pattern occurs, and the travelling waves progress with only the steady attenuation of conductor losses and dielectric losses, while power is transmitted. For loads pre-

senting other impedances, capacitive, inductive or resistive, an interpenetration of stationary and travelling systems may occur.

#### Comparison with Antenna Theory.

—We have introduced this view of transmission impedance because resonator theory is not unconnected with ordinary ideas of radio aerials if we recognise that the latter are just transmission lines of a special kind whose end reflections depend on how they are loaded and grounded. Some of the energy delivered to a line may be not simply reflected to and fro between its ends but thrown off into space: this is taken into account when we calculate a "radiation resistance,"  $R_r$ , which is the fictitious load capable of consuming a power equal to that radiated if it were placed in series with the line. So a resonant line becomes an efficient aerial if the ratio  $R_r/R_r + R_l$  is not small, where  $R_l$  is the corresponding way of representing the loss by dielectrics and conductors of the system. But, for the resonators needed in U-H-F valves, both of these power-consuming quantities must be as small as possible.

#### Open- and Short-Circuited Lecher Wires.

—The foregoing facts are most commonly seen with the pair of parallel wires into which a Barkhausen oscillator (see previous article) or a magnetron or other U-H-F generator is made to feed: a neon lamp (Fig. 2) across the wires indicates the voltage antinodes of the stationary pattern by glowing with capacitive currents. The wavelength ( $\lambda$ ) will be given by twice the distance between points of maximum excitation of this or any other detector, though the actual location of the first antinode of current or potential depends on whether the termination is an open circuit or a short.

These Lecher wires (so-named after an early worker in this field) obviously form a poor transmission line unless fed into some load offering  $Z_0$ . They form a better resonator than a single line, which is itself the better aerial because each of the pair reduces the radiating efficiency of its fellow.

**The Coaxial Line.**—A transmission line still less efficient as an aerial and far more efficient as a resonator is that in which the two "wires" are coaxial, i.e., an inner enclosed in an outer cylinder. The outer completely prevents the inner from radiating or picking-up, so the composite line is a good feeder if correctly terminated. If, on the other hand, a length which is a suitable multiple of  $\lambda/4$  is taken separately and closed by conducting ends, it forms

an excellent resonator, trapping energy in the form of stationary waves and only emitting the power it gathers by a special outlet in some desired direction. A useful reminder that radio is not the only industry to use such resonators is the X-ray tube of Sloan in California, for which as far back as 1935 he suggested a  $\lambda/4$  coaxial line as a resonant circuit.

**The "Hohlraum."**—From these general properties of transmission lines and the particular properties to be avoided when they become aerials, we reach the extreme case of a non-radiating and sharply tuned container of electromagnetic fields with input and output connecting links which may be metallic probes or loops or an electron beam, and which hardly disturb complete enclosure. We have

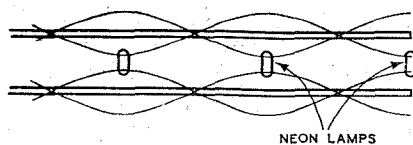

Fig. 2. Lecher wires open-circuited, with positions of neon lamps indicating voltage antinodes.

taken the coaxial line as the resonator most obviously related to conventional wire circuits, but the "Hohlraum"—as it was called at first from the German words meaning "hollow space"—can be any kind of closed box. It evades the radiation losses from an open transmission line and the hopeless inefficiency at U-H-F of the parallel coil and condenser or so-called "tank" circuit. To all such parallel resonant circuits, however, the "Hohlraum" is strictly equivalent through its distributed capacity and inductance.

Other shapes of interest are the sphere, the distorted sphere, and the single cylindrical or rectangular pipe. These single surface resonators, in contrast to the Lecher pair or the coaxial pair, require the further notion of a single-conductor "wave-guide."

**Wave-Guides with "Cut-Off" Frequency.**—The coaxial line, like the Lecher pair, resembles superficially the "out and return" connections of DC circuit practice. Recent work has shown that an excellent transmission line or "wave-guide" can be made from a single conductor such as a pipe, empty or filled with dielectric. This presents no obvious return or earth, but along it power is carried by means of its interior dielectric with the conducting boundary to "guide" it, provided only the frequency exceeds a critical

minimum which may be extremely high. Lord Rayleigh in the last century predicted that hollow pipes should be able to transmit the energy of an electromagnetic field if the wavelength becomes so small as to be comparable with the linear dimensions of the cross-section. In particular, for a cylinder the Bessel function solution of Maxwell's equations gives the criterion for passage of waves as an internal diameter equal to or greater than  $3.68 \lambda/2\pi$ . The numerical factor varies for different "modes" of oscillation, the above being associated with the lowest possible frequency. Obviously, for radio wavelengths above a metre the practical problem of size makes these wave-guides fantastic and uneconomic, but with wavelengths of a small fraction of a metre they may well supersede the conventional forms of transmission.

It is not easy to picture the mechanism of the wave-guide if one is tied to ordinary circuit conventions: the latter have made little use of "line of force" diagrams, but for wave-guides the definite mapping of electric and magnetic lines becomes necessary in a way forgotten or neglected in DC and AF or even ordinary RF engineering.

These maps do show up some striking features in coaxial or other "two conductor" systems, the "guides" form two sides of a "circuit" in which equal and opposite currents flow. Transverse lines of electric force terminate on each guide with a density greatest where the currents are least. There is of course no axial component of electric or magnetic intensity; the "single" type of guide, on the other hand, has the novelty of an axial component. In fact the modes of oscillation can be distinguished according to whether electric or magnetic lines run parallel to the direction of transmission. We illustrate (Fig. 3) one of these modes to indicate this feature which marks off the "pipe" wave from the purely transverse wave of Maxwellian electricity. Compared with the mode in a coaxial line, a dielectric capable of "displacement" current has to take the place of the central conductor when the single pipe carries power. If either of the systems is terminated to produce travelling waves, the E and H lines will be in phase instead of 90 deg. apart.

There have been various attempts to picture the physical mechanism of the "cut-off," or the fact that a wave-guide does not begin to transmit until the wavelength is diminished to the critical size. Mathematical explanations fall back on the passage of a variable into the imaginary domain.

**Electrons in U-H-F Valves—**

at the point of critical frequency; others have usefully considered the wave split into component pairs striking the walls of the guide in a direction which becomes perpendicular to the axis at "cut-off."

**Wave-Guides as Resonators.**—We have introduced the wave-guide on account of its use as a resonator. Just as a coaxial, sliced off at some length, with definite relation to wavelength, made a good resonator when closed by conducting ends, so also can a single pipe. They differ, however, in that the single pipe transmits only by the peculiar mechanism which allows an axial field component, whereas the coaxial also transmits in other modes where the fields are purely transverse. If all possible modes are examined, either length or cross-section or both may be the determining factor in the "natural period" of a transmission line turned into a closed box-resonator. We need only to deform the box and distort the lines of force to accept any geometrical figure as resonator, and we shall notice later what happens in this way to a sphere.

**Impedance and the "Q" of a Resonator.**—Ordinary circuit constants are not always helpful in assessing the factor of merit of these resonators if they become components in a valve for U-H-F. One clue, however, is illuminating; if they are to be excited by electron beams of the order of milliamps at kilovolts, i.e. a voltage/current ratio of a megohm or more, the equivalent impedance of the resonator in parallel with the beam ought to be of the same order of magnitude. Hansen, of Stanford University in California, has shown the directions along which the resonator design can attain this; his argument introduces other parameters now used for judging U-H-F apparatus. For the shunt impedance of a resonator turns out to be  $Q(L/C)^{1/2}$  of which the second factor is the  $Z_0$  which we have already discussed.  $Q$  is the quantity which has recently dominated the choosing of elements in U-H-F design: it is proportional to the energy stored compared with the energy lost in resistive heating, and for these resonators it must obviously be made as large as possible. The commonest way of defining  $Q$  for all sorts of apparatus is the ratio  $\omega L/R$  or  $1/\omega CR$  according to the inductive or capacitative nature of a particular reactive impedance. But in all cases it is important to recognise that  $Q$  is a property of resonant conditions, and that  $R$  is the equivalent series resistance of an entire circuit in which

C and L are elements.

In place of separate computing of L, C, and R as in circuits at lower frequencies, the most useful parameters in U-H-F practice are perhaps these combination terms,  $Q$  and  $(L/C)^{1/2}$  together with  $(LC)^{1/2}$  which is associated with wavelength in the usual manner for all frequencies. Since the angular frequency  $\omega$  at resonance is  $(LC)^{-1/2}$ ,  $\omega L$  must be equivalent to  $(L/C)r$ , so that  $Q$  for many purposes may be written as the characteristic impedance divided by the series resistance. The familiar distinction between equivalent series and shunt impedance in all AC theory then re-emerges in comparing this view of  $Q$  with our former statement that shunt impedance of the resonator is  $Z_0 Q$ . The whole discussion must accord with the fact that impedance approaches pure resistance near a point of resonance.

To estimate orders of magnitude it

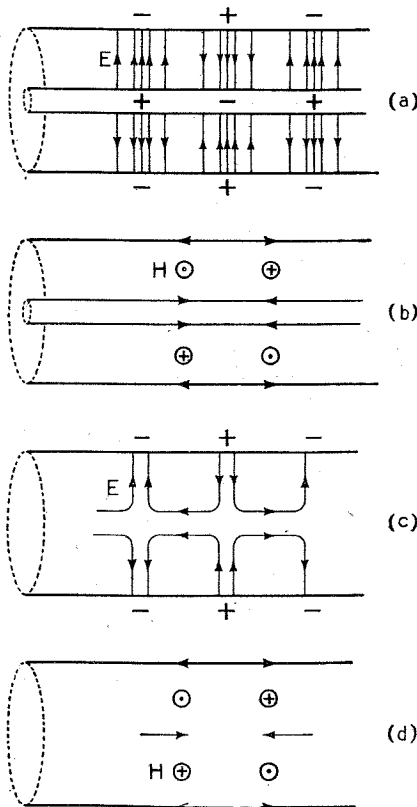

Fig. 3. Standing waves in resonators. (a) Coaxial line (mode independent of diameter) showing maximum electric field (E). No magnetic lines (H) and no current in conductors. (b) Coaxial line conditions  $\frac{1}{2}$  cycle later. Maximum magnetic field, maximum metallic currents and no electric field. (c) Single hollow pipe with electric field at maximum. (d) Hollow pipe  $\frac{1}{2}$  cycle later with maximum magnetic field and "displacement" currents along axis as well as metallic currents in pipe.

is useful to recollect that when L and C, the distributed constants of impedance, are combined in  $Z_0 Q$ , where  $Q$  is a pure number, the numerical ratio between absolute systems of electrostatic and electromagnetic units must be implicit in the combination. This ratio,  $9 \times 10^{20}$ , has the dimensions of a velocity squared, in fact its root,  $3 \times 10^{10}$ , is the actual speed of all radiation in free space in cm. per sec. Since an ohm is equal to  $10^9$  absolute electromagnetic units, the relationship between the systems requires an order of magnitude of 30 practical units of resistance to be included in the dimensions of  $Z_0$ . Some writers have even gone so far as to describe the velocity of light as "30 ohms," a statement which is obscure unless one traces its origin in this purely dimensional argument relating units of one system to those of the other.

The result serves usefully to show, however, that the shunt impedance of a resonator will, in ohms, be of the order of 30 times its  $Q$ . It is clear that the requirement we mentioned, of megohms to match the volt/amp. ratio of an electron beam, will therefore need an enormous  $Q$ , far in excess of that familiar in coils and condensers of ordinary radio.

Now  $Q$  is, from the first of our definitions, the ratio of stored to lost power, so that for a "Hohlraum" completely enclosed by perfectly conducting walls  $Q$  would be infinite. For good but not perfect walls the fields penetrate the boundary material to the slight extent of the "skin effect," familiar in all RF circuits, where currents confine themselves to an ever shallower surface layer of metal as the frequency is raised. If all the electromagnetic energy penetrating the skin is lost in heating,  $Q$  is approximately  $\pi$  times the resonator's volume divided by its surface area times the skin depth  $d$ . For a sphere,  $Q$  is therefore nearly the radius divided by  $d$ , or, from the mathematical theory which accounted for wave-guides,  $\lambda/d$ . For a practical instance, for wavelength of 10 cm. and the skin depth appropriate to copper at 3,000 Mc/s,  $Q$  may reach 50,000, which provides satisfactorily the very high shunt impedance for electron beam excitation. Since  $Q$  also measures sharpness of resonance, the high  $Q$  of a resonator indicates a frequency stabilisation equal to, or even, it is claimed, exceeding, that guaranteed by the quartz crystal of ordinary radio.

**Modes of a Spherical Resonator.**

—The cylindrical resonator has appeared more easy to relate, through

the coaxial, to ordinary transmission line theory, but the sphere has been much discussed because it yields readily to mathematical

amplifiers often have "Hohlraums" of less simple shape than those through which we have been introducing the fundamental physical properties of

Fig. 4. (after Hansen). One mode of oscillation of a spherical resonator. (a) Shows the electric lines at the instant when the magnetic field is zero. (b) Shows the situation  $\frac{1}{4}$  cycle later, when the energy is in the magnetic field which is perpendicular to the plane of this sectional diagram. The intensity and distribution of each field are also shown graphically.

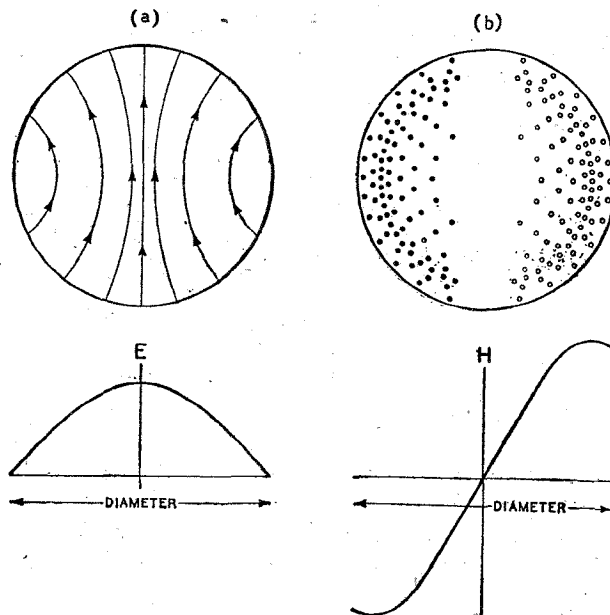

treatment; so we illustrate (Fig. 4) one of its modes for comparison with the lines of force in the cylinder. It turns out that a sphere has to be deformed in certain directions to be of most use when excited by a cathode ray beam, so that the velocity-modulation tubes now in practice as generators and

resonators. The practical utilisation of those properties will be dealt with in the next article, where the transit time of an electron beam across a particular type of resonator will be shown to fix the behaviour of the Klystron type of oscillator and other devices.

### BOOKS ON WIRELESS

issued in conjunction with the "Wireless World"

	Net Price	By Post
"FOUNDATIONS OF WIRELESS," by A. L. M. Sowerby, M.Sc. Third Edition revised by M. G. Scroggie, B.Sc., A.M.I.E.E. ....	6/-	6/6
"RADIO LABORATORY HANDBOOK," by M. G. Scroggie, B.Sc., A.M.I.E.E. Second Edition Revised and Enlarged ...	12/6	13/1
"WIRELESS SERVICING MANUAL," by W. T. Cocking, A.M.I.E.E. Sixth Edition Revised and Enlarged ...	6/-	6/6
"HANDBOOK OF TECHNICAL INSTRUCTION FOR WIRELESS TELEGRAPHISTS," by H. M. Dowsett, M.I.E.E., F.Inst.P., M.Inst.R.E. and L. E. Q. Walker, A.R.C.S. Seventh Edition ...	25/-	25/9
"WIRELESS DIRECTION FINDING," by R. Keen, B.Eng. Hons. Sheffield, A.M.I.E.E. Third Edition ...	27/6	28/3
"RADIO DATA CHARTS," by R. T. Beatty, M.A., B.E., D.Sc. Second Edition ...	5/-	5/5
"TELEVISION RECEIVING EQUIPMENT," by W. T. Cocking, A.M.I.E.E. ...	8/6	9/-
"RADIO INTERFERENCE SUPPRESSION," by Gordon W. Ingram, B.Sc. ...	5/-	5/4
"LEARNING MORSE," Ninth Edition ...	6d.	7½d.
"RADIO DESIGNER'S HANDBOOK," Edited by F. Langford Smith, B.Sc., B.E. ...	10/6	11/1
"THE WIRELESS WORLD" GREAT CIRCLE PROJECTION MAP ...	2/-	2/3
B.V.A. LIST OF EQUIVALENT AND PREFERRED ALTERNATIVE VALVES ...	1/-	1/1

Obtainable from Leading Booksellers and Railway Bookstalls or by post (remittance with order) from

ILIFFE & SONS LTD., Dorset House, Stamford Street, London, S.E.1

# GALPINS

**ELECTRICAL STORES**  
 21, WILLIAM ST., SLOUGH, BUCKS.  
 Phone: SLOUGH 20855 TERMS: Cash with order

**MOTOR-DRIVEN ALTERNATOR**, direct coupled, motor, 110 or 220 v. D.C. input, complete with starter; alternator output 220 volts, 50 cycle, single phase, 176 watts, fitted governor; mounted on teak beams and fitted handles for carrying, condition as new, wear nil, size overall 40in. by 9in. by 11in. Price **£16**, carriage forward.

**DYNAMO**, 110 volts, 60 amps. shunt wound, interpole, ball bearing, speed 1,750 r.p.m. continuous rating. Price **£15**, carriage forward.

**EX G.P.O. MORSE INKER AND TAPE RECORDER**, complete with actuating relay and tape reel, mounted on mahogany base, clockwork model, in good clean condition and perfect working order. Price **£12**, carriage paid.

**A.C. MOTORS**,  $\frac{1}{2}$  h.p., 200/250 volts, 50 cycle, single phase, offered for repair, the starter windings and the running windings are guaranteed sound, but the centrifugal starting switch is damaged or broken; this can be overcome by scraping switch, bring out the four leads and use a twin knob switch. Note both windings are guaranteed. Price **30/-**, carriage 2/6.

**DITTO A.C. MOTORS**,  $\frac{1}{2}$  h.p., dud windings, only offered for rewinding. Price **15/-**, carriage 2/6.

**SHEET EBONITE**, size 12in. by 11in. by 1/32in., best quality. Price **4/-** per doz., post free.

**ELECTRIC LIGHT CHECK METERS**, well-known makers, first-class condition, electrically guaranteed, for A.C. Mains 200/250 volts 50 cy. 1 phase 5 amp. load, **10/-** each; 10 amp. load, **12/6**; carriage 1/-.

**D.C. ELECTRIC LIGHT CHECK METERS**, 200/250 volts, 5 and 10 amps., in new condition and electrically perfect; **7/6**, post 1/-.

**AUTO. CHARGING CUT-OUT AND VOLTAGE REGULATOR**, ex-R.A.F., suit any dynamo up to 20v. at 15 amps., fully adjustable, with wiring instructions, complete in metal case, **3/6**, post 9d.

**X-RAY TRANSFORMER**, 110/220 v. A.C. input; output 45,000 volts at 7 milliamperes, as new, small portable type. **£12/10/-**, carriage forward.

**ROTARY CONVERTOR**, vertical type, 220 v. D.C. input; output 150 volts at 150 watts, complete with transformer for 110 to 240 volts, complete with starter, stand good overload. Price **£6/10/-**, carriage forward.

**AUTO TRANSFORMER**, 1,500 watts, tappings 0-110-200-220 and 240 volts for step-up or step-down. Price **£5**, carriage paid.

**110 V. BULBS** 150 C.P., Edison screw fitting, half watt gas-filled, **2/6** each, post free, or **22/6** per doz., post free.

**FRACTIONAL H.P. D.C. MOTORS**, for 110 volt and 220 volt D.C. mains, only from 1/20th to  $\frac{1}{2}$  h.p., state size and voltage required. Price **10/-** each, carriage 1/-.

**LARGE TRANSFORMERS** for rewinding, rating unknown, size 1 kW. auto. Price **17/6**, carriage paid.

**LARGE TRANSFORMERS** for rewinding, size 2 kW. auto., rating unknown. Price **30/-**, carriage forward.

**WOUND RESISTANCES**, mounted on enamelled iron, overall size 12in. by 1½in., resistance 6 ohms, wound with 18 gauge chrome nickel wire, new and unused. Price **2/6** each, post free, or **25/-** per doz.

**HIGH-VOLTAGE CONDENSERS**, size 4in. by 4in. by 10in. 1 mf. 4,000 v. working. Price **15/-**, carriage.

**HIGH FREQUENCY TRANSFORMERS**, 75 v. A.C. input at 300 cycles; output 5,000-0-5,000 v. at 500 watts. Price **45/-**, carriage forward.

**10 K.W. AUTO TRANSFORMER** in case, 110 v. to 220 v. or vice-versa, in new condition. Price **£15**, carriage forward.

**AIR PRESSURE GAUGE**, 9 in. dia., scale 0-4,000 lbs. per square inch, in gunmetal. Price **£4** each.

**4-PIN BASE BOARD VALVE HOLDERS**, good condition, **3/6** per doz., post free.

**PYE WAVE CHANGE SWITCHES**, 2-Band, **2/6** each, post free.

**SMALL TRANSFORMERS** for rewinding, wire not guaranteed, **3/6** each, post free.

**3 K.W. AUTO TRANSFORMER**, tapped from 0 to 100 and then every 10 volts up to 300 volts, condition as new. Price **£10**.

# ECKERSLEY REPLIES

## —to Critics of his Wire Broadcasting Scheme

THE letters criticising my proposals for post-war broadcasting,<sup>1</sup> have made me feel rather sad. I did believe that people were beginning to think more communally. The misrepresentation of what I implied and stated can only come from those defending sectional interests.

But instead of taking the objections and criticisms point by point, I believe it will be much more helpful if I may first summarise my ideas, so that there can be no further misunderstanding by fair-minded people.

My proposals are based on the conception that broadcasting becomes more and more valuable to the community as it can give a greater number of different types of programme. This is a liberal-democratic conception. Some people dislike liberal-democratic conceptions. These people have a right to complain of my proposals. But this article is addressed to those who, apparently, believe in liberty and democracy.

### Wire or U-S-W?

Present-day broadcasting cannot give a wide choice of programmes. I envisage a broadcasting system in which the listener could enjoy, in his own home, the variety of interest and entertainment which is available to him by visiting theatres, concert halls, music halls, libraries and political meetings, etc., etc. Such a choice, obviously, can only be made possible if there is a greater number of channels for programme distribution. This can be achieved by using either wires or ultra-short-wave wireless transmission. In both these systems the range of the broadcast is limited; in both, the programmes may be controlled by a "vested corporation." In neither system can the listener reach out abroad. In short, if the number of home programmes is to be increased by any known means, it will become impossible, unless space broadcasting is also continued, for listeners to pick up foreign programmes. That is why I have never suggested that space broadcasting should be shut down. My proposal is that both systems, should function simultaneously. Indeed, my proposal would enable ordinary medium- and long-wave broadcasting to function

more efficiently, because there would be fewer stations, which could therefore be of higher power. Those who wished to listen to these stations would be at liberty to have sets to do so. But the new system for home broadcasting would give a very much greater choice of programmes, some of which might, and should, be foreign station relays.

It has been suggested that this system of home broadcasting could be dominated by a dictator. This danger, surely, would exist also for the B.B.C. It seems to me, however, that before broadcasting can be dominated by a dictator, there must also be a dictator to dominate it. And if such a person is to seize power, surely it is just as dangerous to have printing presses lying about for him to seize as any broadcasting system—B.B.C., wire broadcasting or wireless transmissions by ultra-short waves.

In short, all I am seeking is a means to give the listener a wider choice of programmes than he gets to-day; in other words, a more democratic broadcasting system; and I see in the use of wires or ultra-short waves a means to do it. But I suggest that ordinary space broadcasting should continue, on fewer and higher-powered stations. My preference for wire broadcasting, rather than ultra-short waves, is based on the principle that wires should be used wherever they will serve, so that wireless may be kept free for mobile services.

### Minor Details

The following are some minor points which do not seem to have been fully understood.

When I stated that I "disregarded the means to an end and assumed they could be found," I was referring to finance, not to technicalities. We can find plenty of money for the war; I assume that we might also find money

for peacetime projects of value to the community. Why this should be read as an attempt to "undermine leaders of the profession" I cannot understand. In any case, what would prompt such iconoclasm?

I have no desire to kill the amateur movement. Is space broadcasting essential to the experimenter? I have heard plenty of amateur transmissions which seem to prove that it is not.

That the radio industry would be damaged if my proposals were adopted, I doubt. But in any case I had hoped that the idea that rationalisation damages industry had by now passed away. A steam shovel may replace fifty men with spades, but fifty men with spades replace five thousand men with teaspoons.

I did not mean to suggest that television could be distributed over the mains. I do not think it possible to do so. I think, nevertheless, that it could and should be distributed on suitable wire networks, which, as I have already said, would be the most efficient way to do wire broadcasting.

### Interference

I implied, according to one correspondent, that wire broadcasting overcomes all interference. So it does. But the problem of overcoming it varies according to the system employed. If special cables were used, the problems would be negligible. Practical experiments prove that it is quite practicable to overcome noise on the mains or the telephone network.

The reduction in size of the receiver comes about because the signal-to-noise ratio in wire broadcasting is much greater than in space broadcasting; thus fewer radio-frequency amplifying valves are necessary. In fact, a wire broadcasting receiver only requires two valves and very simple filters. I would not suggest reducing audio fidelity, because one of the great advantages of wire broadcasting is that it gives faithful reproduction.

In conclusion, I am grateful to the Editor of *Wireless World* for his fair-mindedness in allowing me space to set out my proposals, however horrifying they may be to those with sectional interests. I think the record of *Wireless World* is enough to guarantee that the schemes I have proposed are not anti-social, technically unsound, or irresponsible.

P. P. ECKERSLEY.

### GOODS FOR EXPORT

The fact that goods made of raw materials in short supply owing to war conditions are advertised in this journal should not be taken as an indication that they are necessarily available for export

<sup>1</sup> *Wireless World*, December, 1941 and January, 1942



# D-F DEVELOPMENTS

## Bearing Indicator for Ground Stations

FOR a number of years DF equipment using the directional loop has been used to enable aircraft pilots to determine their positions under conditions of poor visibility. Because of the necessity of a skilled operator to work the equipment and the time required to take a reading it was necessary for the plane to make a special transmission for the direction-finding determination. Apparatus which will determine an aircraft's direction instantly and automatically has been developed in the U.S.A. by Bell Telephone Laboratories, according to the *Bell Laboratories Record* for November. It is an azimuth-indicating radio receiver, operating in the 2- to 7-megacycle bands, which gives visual indication of the direction of the source of any radio waves to which the receiver is tuned. The collector, or aerial, system may be located at a site free from electrical noise, while the indicator panel may be located at a regular operating point where personnel is available for observing the directional indications.

The antenna system consists of four vertical dipoles located at the corners of a square with a fifth dipole at the centre. The four corner antennas are used for determining direction. The centre antenna serves as a reference of radio-frequency phase to permit differentiation between directions 180 degrees apart, and also it receives the normal communication signals. This form of antenna responds only to the vertical component of the electric field, since the horizontal component is cancelled out.

### Suppressed Carrier

Each pair of directional dipoles is connected to the input of a pair of modulators, which are also supplied with an audio modulating frequency. The carrier and modulating frequency are both suppressed; only the sidebands remain. The outputs of the directional modulators, together with the output of the centre antenna, are then combined and passed to the radio receiver. The three components are separated at the output of the receiver, and the signal is fed to a loudspeaker, and the two directional components to the plates of a cathode-ray tube. The cathode-ray tube has two pairs of deflecting plates at right angles to each other. The rectified output of one pair of dipoles tends to deflect the spot

along the line of one pair of plates, and the output of the other pair of dipoles along the line of the other pair of plates. The indication on the screen will then be a straight line whose direction depends upon the relative strengths of directional signals applied to the deflecting plates. If there were only the two directional sidebands at the detector input in the radio receiver there would be uncertainty between directions 180 degrees apart. The output of the centre antenna, however, which is present with the two directional sidebands, serves as a reference of sign, with the result that the bearing is correctly indicated at all times during the flight.

The receiver has facilities for choosing any one of ten frequencies used for aircraft communication. Any of the ten frequencies may be selected by a dial similar to the ordinary automatic telephone dial, and a light in a bank of lamps indicates which frequency is being received.

## Electric Soldering Irons

### A. Wartime Economy

IN wireless work, where most fluid fluxes are banned on account of their corrosive properties, special kinds of soldering paste are used. Generally speaking, if a soldering iron becomes overheated to such an extent that the tinning is burnt off, it becomes necessary to file the copper bit heavily before it can be re-tinned. The life of the iron is thus greatly reduced, and metal is wasted. This waste can be avoided by adopting the following method.

With the hot iron first melt half a dozen pellets of solder on to a flat iron plate. Then take an old rough file and dip the end of it into the flux and rub the file tip over one surface of the bit. The heat of the iron causes the flux to flow over the cleaned part. Next pick up a pellet of solder from the iron plate by striking it smartly with the cleaned surface. Give another light rub with the flux-coated file tip, and a clean, bright, tinned surface will result. Repeat for the other surfaces of the bit.

This may not be the quickest way to re-tin an iron, but it is claimed to be the most economical, because heavy filing is not necessary.

L. L. J.

# PREMIER RADIO

## NEW PREMIER S.W. COILS

4- and 6-pin types now have octal pin spacing, and will fit **International Octal** valve holders.

4-PIN TYPE			6-PIN TYPE		
Type	Range	Price	Type	Range	Price
04	9-15 m.	2/6	06	9-15 m.	2/6
04A	12-26 m.	2/6	06A	12-26 m.	2/6
04B	22-47 m.	2/6	06B	22-47 m.	2/6
04C	41-94 m.	2/6	06C	41-94 m.	2/6
04D	76-170 m.	2/6	06D	76-170 m.	2/6
04E	150-350 m.	3/-	<b>CHASSIS MOUNTING OCTAL HOLDERS</b> 10½d. each.		
04F	255-550 m.	3/-			
04G	490-1,000 m.	4/-			
04H	1,000-2,000 m.	4/-			

**Premier 2-Gang S.W. Condenser**, 2 × 00015 mfd., with integral slow motion, complete with pointer, knob and scale, **10/6**.

## SHORT WAVE CONDENSERS

**Trolital** insulation. Certified superior to ceramic. All-brass construction. Easily ganged.

15 m.mfd. ....	2/4	100 m.mfd. ....	3/-
25 m.mfd. ....	2/6	160 m.mfd. ....	3/7
40 m.mfd. ....	2/6	250 m.mfd. ....	4/-

## BAKELITE DIELECTRIC VARIABLE CONDENSERS

.0005 mf. Suitable Tuning or Reaction, **1/9** each.

## S.W. HF. CHOKES

10-100 m., **10½d.**  
High-grade **Pie-wound** type, 5-200 m., **2/6** each.

## MOVING COIL SPEAKERS

**Celestion** 8in. P.M. Speaker, **25/-**.  
**Plessey** 8in. 2,000 ohms field Speaker, **15/-**.  
Both speakers are complete with output transformer.

## PICK-UPS

**Crystal Pick-up, Rothermel Junior Model**, **31/10**.  
**Rothermel Crystal Pick-up head**, will fit any gramophone tone arm, **34/9**.

## PREMIER MICROPHONES

**Transverse Current Mike.** High-grade large output unit. Response 45-7,500 cycles. Low hiss level, **23/-**.  
**Moving Coil Mike.** Permanent magnet model requiring no energising. Response 90-5,200 cycles. Output, 25 volt average. Excellent reproduction of speech and music, **49/-**.  
**Crystal Microphone, Rothermel D. 105**, **63/-**.

## PREMIER REPLACEMENT VALVES

4-volt A.C. types, 5-pin. **ACHL, ACL, ACSI, G**, all **5/6** each.

## "LEARNING MORSE?"

Then purchase one of the new practice Oscillators. Supplied complete with valve, on steel chassis, **27/6**. Practice key, **3/3**, TX key, **5/9**. Brown's Headphones, **17/6** pair.

## PREMIER BATTERY CHARGERS FOR A.C. MAINS

**Westinghouse Rectification**, complete and ready for use. To charge 6 volts at 1 amp., **29/6**. 12v., 1a. (also tapped for 2 and 6v.), **37/6**. 6v. at 2a. (also tapped to charge 2 and 4 volts), **48/-**.

## MATCHMAKER UNIVERSAL OUTPUT TRANSFORMERS

Will match any output valves to any speaker impedance. **11** ratios from 13-1 to 80-1, 5/7 watts, **20/-**. 10/15 watts, **26/-**.

Write for new Value List.

## PREMIER MAINS TRANSFORMERS AND SMOOTHING CHOKES AGAIN AVAILABLE.

Write for Details.

**ALL ENQUIRIES MUST BE ACCOMPANIED BY 2½d. STAMP.**  
**ALL ORDERS LESS THAN 5/- 6d. POST EXTRA.**

# PREMIER RADIO CO.

## ALL POST ORDERS to:

**JUBILEE WORKS, 167, LOWER CLAPTON ROAD, LONDON, E.5. (Amherst 4723.)**

## CALLERS to:

**JUBILEE WORKS, or 169, FLEET STREET, E.C.4. (Central 2833.)**

# UNBIASED

## Radio Pipe-preserver

NOW that the winter lies behind us and there is no danger of being arrested for presenting a free weather report to Adolf, it is permissible to reveal that on several occasions during January the thermometer fell below freezing point, and many foolish people who take no precautions in these matters suffered from burst pipes. It was as a result of this weather that a very ingenious wireless solution to the frozen-pipe problem was revealed to me.

I happened to be staying overnight with a member of the *Wireless World* staff at his place in the country. We had retired to rest fairly early as we had to be up at three o'clock in the



"Facilis Descensus . . ."

morning to listen to the running commentary on the Joe Louis fight from New York. On going to bed I speedily found that all chance of getting to sleep was vetoed by a most appalling row which was going on over my head. Some forty or so jazz bands appeared to be holding a competition in the room above me, each striving to outdo the others. Eventually I could stand it no longer, not stopping to slip a dressing-gown over my night-shirt I set out on a tour of investigation.

I speedily found that the mystery deepened as my room was at the top of the house, and the noise was apparently coming from the loft, access to which was by means of the usual ladder and trap door, and so I clambered up into the midst of the inferno of noise. I am by no means superstitious by nature, but I could not help feeling a little alarmed, as I appeared to be surrounded by dance bands on all sides. Unfortunately, I had forgot-

By

FREE GRID

ten to bring any matches, and in order to get some I moved back towards the trap door rather more swiftly than was consistent with dignity. In my haste I overlooked the fact that lofts are for the most part not provided with floorboards, and that it behoves one to tread warily on the rafters, carefully avoiding the laths and plaster in between.

Almost before I knew what was happening my leg went through the ceiling of the bedroom below, whence came piercing screams for assistance in a feminine voice with an output that rivalled even the din of the dance bands all around me.

When I had finally been rescued from my undignified position, and explanations and apologies had been given and accepted, I learned the explanation of the mystery. My host, knowing that his pipes were unprotected and, like Hitler, being caught unawares by the unexpected severity of the weather, had gone into the *Wireless World* laboratory before leaving for home a few days previously, and shovelling up a dozen or so midget sets which he had found there on test he had installed them all in his loft, carefully wrapping their connecting flex round the pipes. This flex is, as you know, used in a large number of midgets for voltage dropping purposes, and develops considerable heat.

While the idea is, of course, a good one, it passes my comprehension why it did not occur to him to stop the infernal racket by removing the leads and joining them all in series. The resistance of these leads is usually about 150 ohms per yard, and the carrying capacity 0.3 amps, and so, as you can easily calculate for yourself, two or three of them joined in series will develop quite enough heat to protect a very respectable length of piping without the slightest risk of burning out, owing to the fact of their being greatly underrated. In addition, the wattage is considerably less than that of an ordinary electric lamp, and so even if several of these radio pipe preservers are used, the electric light bill will not be greatly affected. In any case, it will be infinitely smaller than a plumber's bill.

## Brains Trust Wanted

I DARESAY that there are some of you whose war work is still not sufficiently near to 100 per cent. all-out to prevent your wasting the country's time by reading newspapers and listening to the B.B.C.'s idle chatter. If so, it will not have escaped your notice that during December an Act of Parliament was passed calling upon us relics of the last war to take down our bows and arrows from the museum shelves and come and clear up this little bit of trouble you younger ones have managed to get yourselves into by not taking the advice of us elder statesmen and squashing Adolf way back in 1933 before he propelled himself to power by PA.

There is, however, one very important point to be attended to before I don my wings and climb into the cockpit of my Spitfire, in order to take off for Tokyo, and that is that I must arrange for somebody to take over my duties of contributing each month to the pages of *Wireless World* and *Wireless Engineer*. The trouble is, of course, to get hold of the right man, a most important thing. I am, therefore, asking those of you who think you can do the job to send me in a list of your qualifications.

As a very rough guide I would point out that, apart from being able to read and write and being in possession of



Taking off for Tokyc.

such bare necessities as literary and artistic ability, and an honours degree at some recognised seat of learning, you must be able to handle editors and wireless manufacturers firmly, but at the same time gently, as it must be remembered that, after all, they are human beings.

The most important thing of all, of course, is the ability to contribute each month the page of "Unbiased." The other contributions, including those to *Wireless Engineer*, don't matter so much, as in any case it should not be difficult to get some-

body from the local labour exchange to attend to them. I must, therefore, ask you to submit for approval a specimen page of "Unbiased," complete with illustrations, headlines, correct spelling and punctuation, all ready for handing over to the printers.

If I can only get enough specimen pages to tide over the few years until I attain the age at which senior officers are compulsorily retired on half-pay, I shall be able to carry on with it myself for the remainder of the war, thus following the example set by a certain disreputable section of the wireless industry who in the palmy days of peace used to advertise well-paid servicemen's jobs, each applicant for the job having to prove his ability by repairing a set, he, thereafter, hearing nothing further about the vacancy.

## For Marine Operators

A New Edition of the "Handbook"

THE fact that another edition of the well-known Handbook of Technical Instruction for Wireless Telegraphists has been found necessary is a measure of the continuous progress which marine wireless communication makes. This book, by H. M. Dowsett and L. E. Q. Walker, which is a complete textbook for the embryo sea-going wireless operator, first appeared in 1913, and has been re-written from time to time. In his foreword the original author explains that owing to the increasing complexity of the subject he has

found it desirable to bring in as co-author one who possesses wide experience of modern marine apparatus. The chapters, which were completely rearranged in the previous edition, remain under the same headings, but many of them have been subjected to extensive re-writing. Many changes and improvements in apparatus which have occurred since the previous edition have been duly recorded. The book can be obtained from Iliffe and Sons Ltd., Dorset House, Stamford Street, London, S.E.1, at a cost of 25s., or, including postage, 25s. 9d.

## From the World's Journals

SOME 300 articles on wireless and allied subjects, which have recently appeared in over forty journals published in nearly a dozen countries, are abstracted or referred to in the Abstracts and References section of the March issue of *Wireless Engineer*. Many of the abstracts are of considerable length, and in all 27 pages are devoted to the section, which, in the present circumstances, is becoming increasingly valuable as a source of information on advances in wireless engineering.

In addition to this regular feature of our sister journal, which is published on the first of the month, the March issue contains an article on "ageing" and tropical humidity tests of radio components as well as the first of two articles describing methods of temperature compensation of condensers.

Copies of *Wireless Engineer* are obtainable to order through newsagents, or direct from our publishers at Dorset House, Stamford Street, London, S.E.1, at 2s. 8d., including postage.

## Push-Pull Quality Amplifier

THE issues of *Wireless World* in which the original Push-Pull Quality Amplifier was described have long since been out of print, and this is also true of later issues in which from time to time the details were published in connection with certain sets such as the Pre-tuned Quality Receiver. Fortunately, however, the circuit diagrams of the amplifier, both theoretical and practical, are still available, as it was used in conjunction with a special 2RF pre-set quality receiver described a few days before the war commenced.

The amplifier, as used on this occasion, had an output of 7 watts, which is somewhat higher than that of the original instrument. An improved phase-splitting method and a tone-control system with separate adjustments for bass and treble were also described. The valve and other components associated with this tone-control system were actually mounted

on the chassis of the receiver unit, although, of course, there is no objection to their being on the amplifier chassis if the latter is made proportionately larger.

For those who wish to build the amplifier only, the August 17th and 31st, 1939, issues of *Wireless World* contain all the diagrams necessary. Those who wish to study the articles dealing with the theoretical principles of the phase-splitting system and the tone-control arrangement, are referred to the issues dated April 13th and June 8th, 1939, which are fortunately also still available. Those who are already in possession of the original *Wireless World* Quality Amplifier and desire information on the question of coupling it to various types of set, are referred to the issue dated August 16th, 1935, in which a special unit was described for coupling it to any normal type of receiver. This issue is also still available.

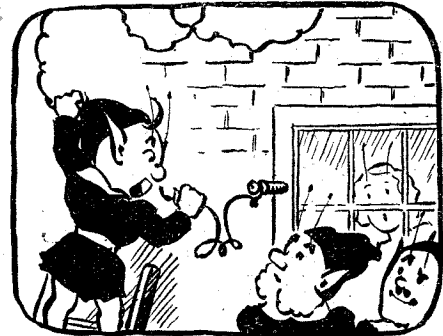

The "Fluxite Quins" at work

"Of all the rummiest fixtures  
This aerial's a packet o' mixtures.  
Hand up the FLUXITE  
Or we'll be here all night  
And I want to go to the pictures."

See that FLUXITE is always by you—  
in the house—garage—workshop—  
wherever speedy soldering is needed.  
Used for 30 years in Government  
works and by leading engineers and  
manufacturers. Of Ironmongers—in  
tins, 4d., 8d., 1/4 and 2/8.

Ask to see the FLUXITE SMALL-  
SPACE SOLDERING SET—compact  
but substantial—complete with full  
instructions, 7/6.

Write for Free Book on the art of  
"soft" soldering and ask for Leaflet  
on CASE-HARDENING STEEL and  
TEMPERING TOOLS with FLUXITE.

TO CYCLISTS! Your wheels will  
NOT keep round and true unless the  
spokes are tied with fine wire at the cross-  
ings AND SOLDERED. This makes  
a much stronger wheel. It's simple—with  
FLUXITE—but IMPORTANT.

## THE FLUXITE GUN

puts Fluxite where you want it by a simple pressure. Price 1/6, or filled 2/6.

FLUXITE LTD.  
(Dept. W.W.),  
BERMONDSEY  
STREET, S.E.1.

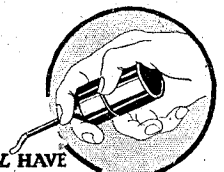

ALL MECHANICS WILL HAVE

**FLUXITE**  
IT SIMPLIFIES ALL SOLDERING

## Letters to the Editor

### Morse Symbols : Training Technicians : Transit Time Limitations

#### Morse : Graphical Representations

THERE is food for thought in "Free Grid's" amusing remarks about morse in the February *Wireless World*. I, too, have mused on the possibility of using better symbols than dots and dashes to conjure up a mental impression of rhythmic sounds, but my conclusion is that, *providing the initial teaching is correct*, the existing symbols are adequate.

The musical score method is, in any case, definitely "out"; dots, dashes and (more important) the spaces in between them can be used far more suitably to represent rhythmic sounds than a so-called "musical score."

Morse cannot be sent in fox-trot time, nor be given any musical time signature; it has no more the pitch of the note "A" than C sharp if your CW heterodyne control is working. Is not a pause better represented by a blank space than by a crotchet or other musical rest? (Rests were omitted in the example given by "Free Grid.")

No! the G clef and the stave can be dispensed with, and a dot is easier to write and read than a crotchet symbol: "Free Grid" would complain, I am sure, if his beginners started "swinging" morse, and his musical pupils would revolt against such "Music mucked-up!"

BASSETT SILVER.

London, N.W.7.

[<sup>1</sup> No "rests" were needed. The symbol referred to represented SOS, which is transmitted without space.—Ed.]

#### Technical Training

I HAVE read with much interest and amusement the thoughts expressed by Mr. Dalton and others on the subject of technical training.

While not entirely agreeing with Mr. Dalton's views, I am inclined to support them in favour of the other ridiculous interpretations that have been put forward.

Surely it is obvious that, with the radio branch of science, it is impossible to place any time limit on the period of technical training. Year by year new theories are produced and old theories are revised. This fact alone is sufficient to indicate that training in radio technique cannot be limited to a period of time.

With regard to "Subaltern's" statement that he can train a person in a few hours, I should be interested to learn of the type of work for which this "training" qualifies his students. I should also be interested to learn as to what, in "Subaltern's" mind, constitutes a radio engineer.

In my opinion, a person intending radio as a career must have a good grounding in the fundamentals, the period for such grounding depending on the individual's pocket, time, enthusiasm and interest. This initial training can later be supplemented by regular spare-time study. The knowledge then acquired can be kept up to date by the attentive reading of technical journals.

I am prepared to assert that a trainee of "Subaltern's" teaching would find it impossible to pass an examination such as the City and Guilds Final. This qualification, to my mind, should be held by all those who designate themselves "Radio Engineers." LESLIE LEDWARD.

Huddersfield.

I THINK Mr. Dalton's letter in *The Wireless World* for January, 1942, is an attack on the electrical engineer instead of being, as he intended, constructive criticism on the present method of training electrical and radio engineers. It is obvious that Mr. Dalton prefers to call himself a radio engineer, as he is then, according to his letter, in a position to discuss the relative qualities of the electrical and radio engineer.

It would appear he has not made a very comprehensive study of power electrical engineering, otherwise the opening paragraph of his letter would never have been written. If he would care to go into some of the largest power stations, or acquaint himself with some of the problems associated with power transmission, he would change his mind. He will find not only has a first-class electrical engineer a good working knowledge of radio communications and electronics, but has to be an authority on mechanical, structural and heat engineering, and on economics.

The Editor does not necessarily endorse the opinions of his correspondents

Although Mr. Dalton admits the rapid progress made in electrical and radio engineering, he has omitted to mention the electronic engineer who bridges the gap between the electrical and radio engineer, and who would relieve him of his "standards of physics and optics above the B.Sc. standard."

Mr. Dalton's programme of the training of such a radio engineer as he describes is, with the present facilities, almost an impossibility.

H. L. PEDDLE.

Froyle, Hants.

#### U-S-W Limitations

YOUR contributor, Dr. Johnson, in discussing the transit time of electrons in UHF oscillators (March, 1942), states that the speed of the electrons varies as the square root of the anode voltage. This is approximately true for lower voltages, but does not allow for the increase in mass of the electron at higher velocities.

A continuation of Table I for higher values would read as follows:—

Anode Volts.	Min. Time to travel 1 cm.
400,000	$0.383 \times 10^{-10}$
800,000	$0.348 \times 10^{-10}$
$\infty$	$0.333 \times 10^{-10}$

From this it can be seen that for higher voltages the transit time is practically independent of the voltage, and the electron is then travelling very close to its limiting velocity—that of light.

It can be seen that this constitutes a far more serious *ultimate* snag than given by mere square root variation in velocity with voltage.

Dublin. B. MACQUILLAN.

#### Transformer-less Power Equipment

I FEEL that Major W. T. Cocking's very interesting contribution on Voltage Multiplying Rectifiers should not be considered complete without a footnote with reference to the dangers arising from the use of transformer-less power equipment. In this country power packs operating without transformers are rather the exception than the rule, and for this very reason warning is necessary on the point.

In properly designed equipment there is no DC connection between the circuit and the chassis, the only electrical connection to the chassis being through a single condenser between the chassis and the negative side of the rectifier supply. In power packs "hooked-up" for experimental purposes the chassis is, of course, exposed, and there is a constant risk of personal contact. As a very necessary precaution the chassis should be connected to earth either permanently, or, if that is not possible, then before the power is switched on each time the apparatus is used. If this is done the worst result—if the power line polarity is not correct—will be a blown fuse: otherwise . . .

F.  
Cheltenham.

**Books Received**

**The 1942 Radio Amateur's Handbook**, by the Staff of the American Radio Relay League.—This book, which has appeared annually for the past sixteen years, is usually considered as the *vade mecum* of the American amateur. It provides, in a series of articles, a straightforward and non-mathematical treatment of radio technique, certain modifications having been introduced this year to meet the needs of civil defence. Full data are given of American valves. Pp. 532. 680 illustrations and diagrams. Published by the A.R.R.L. Inc., West Hartford, Connecticut, U.S.A. It may be obtained in this country from Webb's Radio, 14, Soho Street, London, W.C.2. Price 9s. 6d.

**The "Radio" Handbook**, by the Editors of *Radio*.—This book, which is an annual publication, gives a condensed but complete course of modern theory and practice by means of a series of articles dealing with individual aspects of the

subject. Special attention is given to FM and UHF. It is written mainly from the point of view of the American amateur. Details are given for constructing transmitters and receivers and for the design and erection of various types of aerial. Full tabulated data is given of all types of American valves, and also a key to base connections. Pp. 640. 577 illustrations and diagrams. Published by Editors and Engineers, Ltd., 1300 Kenwood Road, Santa Barbara, California, U.S.A. Price 2 dollars.

**The Story of Electromagnetism**, by Sir William Bragg.—An unusual method of explaining the fundamental principles underlying electro-magnetism is used in this book, which is a reprint of a lecture given to cadets of the Air Training Corps. The author puts forward a novel method of explaining the interaction of electrical and magnetic forces when in motion. Another feature is the inclusion of the actual rough drawings sketched in the diaries and notebooks of early investigators like Faraday. Pp. 64. 18 diagrams. Published by G. Bell and Sons, Ltd., Portugal Street, London, W.C.2. Price 1s. 6d.

**The Wireless Industry**

A NEW leaflet (No. 97), describing the Synchronous Time Delay Relay, Type PRL, has been issued by Londex, Ltd., remote control engineers, of 207, Anerley Road, London, S.E.20. The various models cover a time range of from 2 seconds to 28 days.

Instrument dials, dial plates, and control knobs (with direct and slow-motion drive) in a wide variety of types are described in a well-illustrated catalogue (No. C-III-A) issued by Muirhead and Co., Ltd., Elmers End, Beckenham, Kent.

The Liverpool depot of the Edison Swan Electric Co., Ltd., is now at 23, Stanley Street (telephone: Advance 4944).

**New "Wharfedale" LS Units**

ALTHOUGH not available in the present circumstances to the general public without priority orders, it is interesting to learn that two new loud-speaker designs have recently been evolved by Wharfedale Wireless Works, Hutchinson Lane, Brighouse, Yorks.

Both units make use of a new alloy, "Alcomax," which is claimed to be considerably more efficient than standard aluminium-nickel alloys. The midget 3½ in. unit, for instance, has a flux density of 8,000 lines/cm<sup>2</sup> compared with 6,300 for the standard alloy. This unit can be supplied for use as a microphone with a 15-ohm coil, or as a loudspeaker with 2-3-ohm speech coil.

The larger unit is the PA12, which is designed for PA work and has a 1¼ in. centre pole and a 0.05 in. x 7/8 in. gap. Although the magnet weighs only 7½ lb., the flux density is 11,500 lines/cm<sup>2</sup>. The cone suspension includes a large back spider, designed to stand up to hard use.

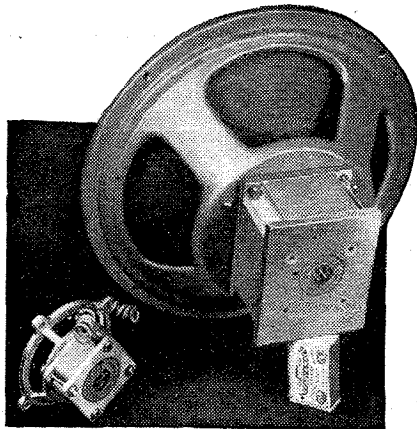

Wharfedale PA12 loudspeaker chassis and 3½ in. Midget microphone - LS unit.

**VORTEXION**  
**50w. AMPLIFIER CHASSIS**

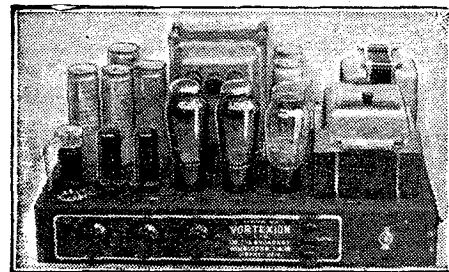

A pair of matched 6L6's, with 10 per cent. negative feed-back is fitted in the output stage, and the separate HT supplies to the anode and screen have better than 4 per cent. regulation, while a separate rectifier provides bias.

The 6L6's are driven by a 6F6 triode connected through a driver transformer incorporating feed-back. This is preceded by a 6N7, 6F3 operating as first stage on microphone only is suitable for any microphone. A tone control is fitted and the large eight-section output transformer is available in three types—2-8-15-30 ohms; 4-15-30-60 ohms or 15-60-125-250 ohms. These output lines can be matched using all sections of windings and will deliver the full response (40-18,000 c/s) to the loud speakers with extremely low overall harmonic distortion.

CHASSIS with valves and plugs.....	£17 10 0
Moving Coil Microphones .....	£5 5 0
Chromium Microphone S'ands from .....	£1 5 0

**Many hundreds already in use**

**15w. AC & 12-VOLT DC AMPLIFIER**

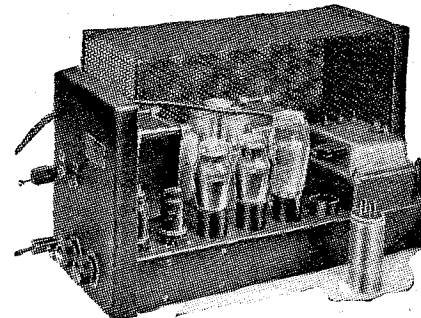

TYPE CP20

This small Portable Amplifier operating either from AC mains or 12-volt battery, was tested by "THE WIRELESS WORLD," October 1st, 1937, and has proved so popular that at customers' demand it remains unaltered except that the output has been increased to 17.2 watts and the battery consumption lowered to 6 amperes. Read what "The Wireless World" said:—

"During tests an output of 14.7 watts was obtained without any trace of distortion so that the rating of 15 watts is quite justified. The measured response shows an upper limit of 18,000 c/s and a lower of 30 c/s. Its performance is exceptionally good. Another outstanding feature is its exceptionally low hum level when AC operated even without an earth connection. In order to obtain the maximum undistorted output an input to the microphone jack of 0.037 volt was required. The two independent volume controls enable one to adjust the gain of the amplifier for the same power output from both sources, as well as superimpose one on the other or fade out one and bring the other up to full volume. The secondary of the output transformer is tapped for loud speakers or line impedances of 4, 7.5 and 15 ohms." Prices

AC and 12-volt CHASSIS with valves, etc.....	£12 12 0
AC only CHASSIS with valves, etc.....	£8 18 6

Gauze Case for either chassis, 12/6 extra.

Plus 25% War Increase on all above prices.

Orders can only be accepted against Government Contracts.

**Vortexion Ltd., 257, The Broadway, Wimbledon, S.W.19. Phone: LIBerty 2814**

# RANDOM RADIATIONS By "DIALLIST"

## Keeping Sets Going

RECENT investigations suggest that something like one million wireless receivers—about ten per cent. of the total number in use—are silent at any given moment just now through defects of one kind or another. In view of the vast importance of radio in wartime as a means of disseminating news and official announcements to the country at large, that is a very serious matter. But I'm not surprised by this seven-figure estimate of lame ducks; it is, in fact, smaller than I'd have expected in view of (a) the average age of the sets now in use, (b) the diminishing number of skilled men available to repair them when they go wrong, and (c) the difficulty of obtaining some essential parts when replacements are necessary. One knows that many old sets must perforce be still in harness since the materials and the labour that might make new ones are urgently required for other purposes. It is inevitable that the demands of the Army, the Navy and the Air Force for men with electrical knowledge should deplete the ranks of the service-men—and naturally the greater their knowledge and skill, the warmer their welcome into any branch of the fighting services. And the demand for radio components for warlike purposes is so great that the radio industry's main object now must be to satisfy it. But it's difficult to say just where the military side begins and the non-military side leaves off in a total war like this. In an emergency I can well imagine that it might be of paramount importance to be able to order the civilian population to do this or that—and radio is the best means of doing so. In towns the authorities could rely on neighbour telling neighbour if some sets were out of commission, but it's very different in country places, where neighbours are often some way apart.

## Any New Sets?

WILL there be any new sets on the market this year to replace those that after the unusually long period of useful life demanded by war conditions are now so cranky that they are not worth repairing? I think that there may be a few. No fresh supplies of materials, raw or otherwise, are finding their way into the hands of manufacturers; but last year quite a few sets were made which could not be put on the market because there

weren't the valves for them. For six months or more the making of valves for domestic sets was forbidden, so urgent were the demands of the fighting forces. This prohibition has been relaxed; a certain number of valves may now be made for broadcast receivers, and it is possible that the sets that were ready last year in everything but valves may now be completed. Even if this does happen there will not be many of them. But there should be enough to replace the receivers that have become genuinely worn out.

## Too Much for the B.B.C.

IN all the years that I've listened to the B.B.C.'s relay of "American Commentary" on Saturday nights, I don't recall a single instance before the 28th of February this year of their having to announce that it couldn't be given because conditions had made it impossible both at the time and earlier in the day. Conditions for short-wave DX certainly were appalling. I was at home on 24 hours' leave and hopefully tried a little exploring. Nothing was to be heard save some of the European locals—and not much of certain of them. Suspecting that goings-on in the sun might be at the bottom of it, I had a look at him the next morning (he was showing himself for once). And there was the finest sunspot I can remember seeing for many a day disfiguring his face. Such a spot was it that many people wrote to the lay papers to report that they had seen "a large planet" moving in front of the surface of the sun. It will be a week or two before the record of cosmic data turns up from the U.S.A.: but I look forward to seeing what it has to report about this solar outbreak. I suspect that it was not a single spot, but a big group of separate vortices.

## Quick Action

Some big sunspots don't make their effects manifest till they are well past the mid-point of the sun's disc. Auroras and interruption of wireless (and sometimes even landline) communication may not be reported until they are nearing the edge towards the end of their transit. But this whacker made itself felt whilst it was still occupying the middle of the stage. It should be back again towards the end of March, and it will be interesting to see how wireless reception is then affected. I don't think there's much

doubt that long-distance short-wave working, particularly with north-westerly stations, will be pretty difficult.

## Delay-relay

At one time the "American Commentaries" were always relayed "straight": there was no potting or canning of reception made earlier in the day. I used to enjoy them enormously when this was done, and so I expect did many other short-wavers—not for themselves alone (though they are usually admirable), but because we could compare directly our own reception with that of the B.B.C.'s short-wave station. Before diversity reception, and, later, MUSA, came into use, amateurs could not infrequently obtain better reception direct than from the medium-wave relay. It was, of course, a real triumph to demonstrate to one's admiring family how much better the amateur expert could do it! But that did not last very long. As a safeguard, transmissions were made at earlier hours and recorded on discs or other means. Then if the straight reception seemed likely to fall down, the recorded talk was put on. Now recording is the regular practice, and with the multiplicity of wavelengths and the excellent receiving systems available, it's rare indeed that the talk isn't delivered to listeners at least ninety per cent. perfect. No longer has the amateur the chance of showing off in the reception of the commentary.

## "Reckless Listening"

REPLACEMENTS, and particularly HTB's, are not too easy to come by in many places, and the avoidance of waste is the watchword of the day. Yet one still comes across owners of battery-operated sets who run them for senselessly long periods, day in, day out. There are still many people who don't realise that one of the surest ways of wrecking a dry HTB in literally double-quick time is to work it continuously for many hours each day under the comparatively heavy load imposed on it by the average wireless set. You know as well as I do the folk who use radio not as something to listen to at intervals, but as a more or less incessant and unheeded background to conversation. That sort of thing spells speedy ruination to HTB's. And it's almost as reprehensible in wartime with mains sets. The

working life of valves is not indefinite, and those who help to swell the demand for them by using their sets at times when they don't need them are not helping the war effort. It's worth thinking over.

### A New Word ?

YOU might think that "radio-  
phone," or, indeed, the use of the prefix "radio" in connection with voice communication at a distance and without connecting wires was something that dated back no great number of years. I seem to remember having seen it stated that "radio" came into use as part of our language at about the time, 40-odd years ago, when Marconi was coming into the limelight. As a matter of fact the term "radio-  
phone" was first used so long ago that even the oldest readers of *Wireless World* must have been infants at the time. Like most of them, I wasn't born! The name was applied round about 1880 to a system of telephony developed by the famous Dr. Graham Bell, the Scotsman whose name will live for ever in the annals of the telephone and the gramophone. In 1878 Bell was still trying to find a completely satisfactory means of impressing the modulation corresponding to sound waves upon an electric current. It was suggested to him that the selenium cell might be used for the purpose, and he developed an apparatus which used it and worked. Sound waves from the lips of a speaker were made to impinge upon a small and very light mirror, free to move. A ray of light focused on to the mirror was normally reflected on to a selenium cell. When words were spoken into the instrument the mirror was set in motion, and the reflected light varied according to the received sounds. Though it evoked much interest when exhibited in America, Bell's radiophone never succeeded in doing anything better than effect the barely intelligible reproduction of the simplest speech sounds.

### Paper Salvage Problems

INCREASED demands on our shipping have intensified the need for conserving paper, and avoiding the waste of anything that might bring grist to the repulping mills. So far as ordinary domestic salvage is concerned, the procedure is already well known. But problems still confront those who have to deal with abnormal matters of paper salvage; all such questions can be dealt with by the Waste Paper Recovery Association, Ltd., 154, Fleet Street, London, E.C.1. Telephone: Central 1345.

## COMMUNICATIONS DEPEND....

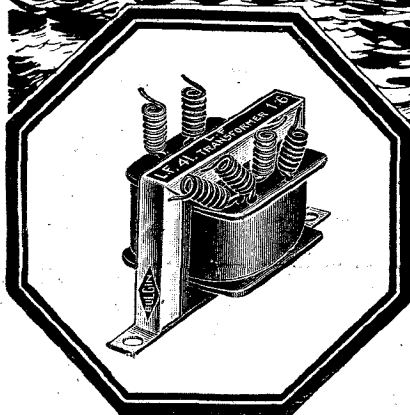
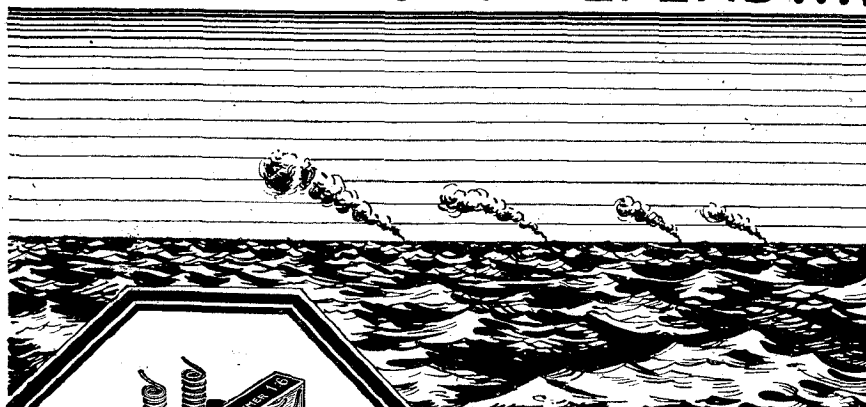

## ON SMALL PARTS....

IN countless instances quite intricate pieces of apparatus are wholly dependent on the proved reputation and reliability of their component parts.

*The Choice  
of Critics*

### BULGIN FOR TRANSFORMERS

THE largest and most extensive range of midget and ultra small intervalve (voltage) transformers in the world. Provided with high- $\mu$  cores and carefully proportioned windings of finest enamelled-copper wires. All joints welded; mono-metallic from start to finish for long life under all conditions.

All products from the House of Bulgin are pre-eminent for superior design and workmanship, and every article bearing our Trade Mark has to pass exacting and exhaustive tests during the course of its production.

We ask the kind indulgence of the Trade on delivery until peaceful conditions return.

ALWAYS DEPEND ON

# BULGIN

REGISTERED • TRADE • MARK

A. F. BULGIN & CO. LTD., BY-PASS RD., BARKING, ESSEX.  
TEL.: RIPPLEWAY 3474 (4 lines).

# RECENT INVENTIONS

## A Selection of the More Interesting Radio Developments

### DIPOLE AERIALS

THE object of the invention is to mount a number of dipole aerials symmetrically about a metallic supporting mast in such a way as to minimise loss of power by currents produced in the mast, and, in the case of a directive system, such as a radio navigation beacon, to avoid the radiation of parasitic fields likely to distort the desired pattern of the "guiding" beams.

The figure shows two pairs of dipoles, A, A<sub>2</sub> and A<sub>3</sub>, A<sub>1</sub> and B, B<sub>2</sub>, and B<sub>3</sub>, B<sub>1</sub> respectively, both being fed through a coaxial transmission line consisting of the metallic mast and an inner conductor N. The limbs A and A<sub>1</sub> of the two opposite dipoles are connected directly

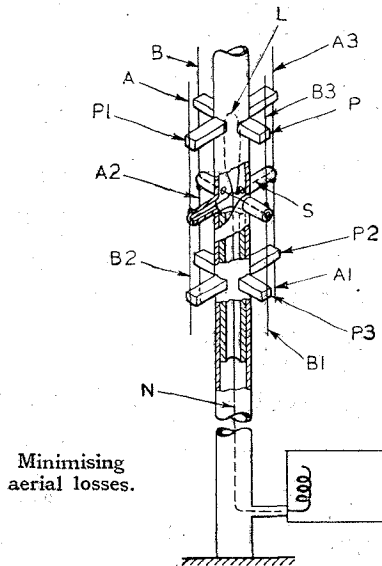

to a stub S integral with the mast, whilst the complementary limbs A<sub>2</sub>, A<sub>3</sub> of the same dipoles are connected to the inner wire N. The limbs B, B<sub>1</sub> and B<sub>2</sub>, B<sub>3</sub> of the other pair of dipoles are similarly arranged, except that their connection to the wire N is displaced by approximately a quarter wavelength owing to the interposition of the looped length L. Upper and lower insulators P, P<sub>1</sub> and P<sub>2</sub>, P<sub>3</sub> serve to support the dipole wires. The dipoles may be energised in phase-opposition to give a double figure-of-eight radiation field, in which currents induced in the mast mutually cancel out, or they may be energised in phase-quadrature to give a circular field.

Marconi's Wireless Telegraph Co., Ltd. (Assignees of W. R. Koch). Convention date (U.S.A.), March 31st, 1939. No. 539398.

### ELECTRON-BEAM RELAYS

IF two focused cathode-ray streams are projected along separate but parallel paths, from individual cathodes to individual anodes or targets, all located on a single tube, it has been found that one stream is capable of influencing the other stream owing to the interaction of their

respective space-charges. As the voltage applied to the control grid of one of the streams is increased, a point is reached where the current conveyed by the other stream first becomes unstable and then suddenly drops in value.

This discontinuity is utilised according to the invention, either to develop square-shaped pulses of current or voltage which can be applied to a variety of uses; or the apparatus can be used as a triggered relay in which the input is applied to the control grid of one of the streams, and the output taken off the target electrode of the other stream.

Marconi's Wireless Telegraph Co., Ltd. (Assignees of A. V. Haeff). Convention date (U.S.A.), March 10th, 1939. No. 539490.

### RADIO-NAVIGATION SYSTEMS

AN aviator flying along an approach course marked out by overlapping radio-beams is liable to take a zig-zag path within the limits of the area of overlap, because the only significant warning he gets of being off-course is where he strays outside the equi-signal field, which may extend for some considerable distance on both sides of the true median line. If, however, he is able to rely at the same time upon a radio compass to give him the actual line of the beacon transmitter, then he can keep on the centre line of the guide-way beams. In addition, when making a blind landing, his radio instruments must show him where he deviates from the glide-path of constant signal strength and indicate the receipt of signals from the marker beacons to show his distance from the landing field.

The invention consists of a radio set designed to indicate an approach or glide-path, and to utilise part of the same circuit to operate a radio compass and also to respond to marker-beacon signals.

Marconi's Wireless Telegraph Co., Ltd. (Assignees of D. S. Bond). Convention date (U.S.A.), April 12th, 1939. No. 539505.

The British abstracts published here are prepared with the permission of the Controller of H.M. Stationery Office, from specifications obtainable at the Patent Office, 25, Southampton Buildings, London, W.C.2, price 1/- each.

### CONTROLLING ELECTRON BEACONS

THE power-handling capacity of an oscillator of the Klystron type depends primarily upon the intensity of the electron beam, and this raises the problem of producing beams of much greater density than is required in the ordinary cathode-ray tube.

It is solved, according to the invention, by using a cathode with an emissive surface many times larger than the required cross-section of the beam. A magnetic field is then applied from a coil so arranged that the lines of force converge from the cathode in the direction of the resonance chambers, remaining parallel whilst the beam passes first the "bunching" chamber and then the absorbing, and finally diverging in the neighbourhood of the collector or target electrode, so that the latter can conveniently be made of the same size as the cathode.

Standard Telephones and Cables, Ltd., and J. H. Fremlin. Application date February 6th, 1940. No. 539422.

### PORTABLE SETS IN SCREENED ROOMS

TO improve the performance of a portable receiver, when used in the cabin of a steel ship, or in a steel railway carriage, or even inside a reinforced concrete building, the frame aerial is adapted to be removed from the set and attached to the nearest window where the natural screening effects of the surrounding conductors is less in evidence.

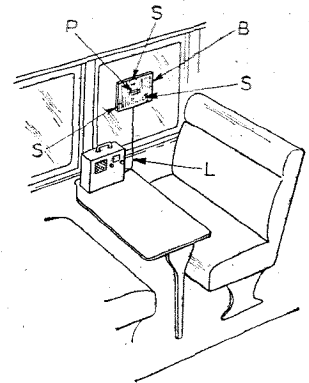

Mounting a detachable frame aerial.

In the figure, the panel B containing a flat-wound frame aerial is shown attached by rubber suction-caps S to the window of a railway carriage. Removal and replacement of the aerial panel is facilitated by a central aperture P, which also serves to prevent any undue obstruction of the listener's view. The aerial may take the form of a separate unit which is only used when conditions are difficult, and is then plugged in by a telephone jack to take the place of a normally built-in aerial.

E. F. McDonald, Junr. Convention dates (U.S.A.), May 4th, June 26th and October 6th, 1939. No. 539979.



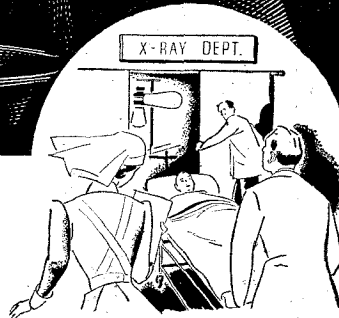

# The shadow of doubt...

'Remove the cause and the effect will cease' is truly said, but for the 18th century physician the cause was too often the subject of doubt. Today we can enlist the aid of X-rays, one of the greatest boons which science has given us. The development of equipment for its safe and accurate use is a story of electrical achievement in which the name of PHILIPS is outstanding. Nor is

this all. In the better lighting of our homes, factories and streets; in the perfecting of radio technique; in the many uses of sound amplification; in the improvement of industrial processes; through untiring research and continued achievement, the House of Philips is identified with the electrical progress of more than half a century.

# PHILIPS



RADIO · LAMPS · X-RAY AND ELECTRO-MEDICAL EQUIPMENT · DISCHARGE LIGHTING  
 SOUND AMPLIFYING INSTALLATIONS · ARC WELDING EQUIPMENT AND ELECTRODES

PHILIPS LAMPS LTD., CENTURY HOUSE, SHAFTESBURY AVENUE, W.C.2

**CLASSIFIED ADVERTISEMENTS.** The charge is 6/- for each paragraph of 2 lines or less, and 3/- for every additional line or part thereof, average 7 words to a line. Each paragraph is charged separately.  
**ADVERTISEMENTS** for the May issue are accepted up to First Post on Tuesday, April 8th, at the Head Offices of Dorset House, Stamford Street, London, S.E.1. or one day earlier at provincial Offices.

THE PROPRIETORS retain the rights to refuse or withdraw advertisements at their discretion. They are not responsible for clerical or printers' errors although every care is taken to avoid mistakes. Cheques and postal orders should be made payable to Iliffe & Sons Ltd. and crossed. Notes are legal tender and cannot be traced if lost in transit.

ADVERTISERS may have letters, other than circulars, addressed to numbers at this office. The words Box 000, c/o "WIRELESS WORLD" must be paid for and a further 1/- added for registration and forwarding replies.  
**DEPOSIT SYSTEM.** Full particulars upon application to the Deposit Dept., "Wireless World," Dorset House, Stamford Street, London, S.E.1.

Ode  
**Partridge**  
 No. 14  
**LIFE**  
 Sorrow reigns  
 Horror grows  
 Death is rife  
 Satan crows.  
 What a game  
 World's gone mad  
 All is lost  
 Life's too bad.  
 That's one view  
 What's the other  
 Faint of heart?  
 Oh, no, brother.  
 Heads well up  
 Face the facts  
 Work and sweat  
 Pay your tax.  
 Then you'll find  
 We're on top  
 Exit Hun,  
 Jap and Wop.

**N. Partridge**  
 B.Sc., A.M.I.E.E.  
 Makers of Transformers and Chokes.  
 King's Bldgs., Dean Stanley St.,  
 LONDON, S.W.1. 'phone: VICTORIA 5035

**NEW RECEIVERS AND AMPLIFIERS**  
 £19/10 Only—"Wireless World" 2R.F. receiver, with push-pull quality amplifier chassis, 10 valves, including tone control stage, 8 watts triode output, ideal for quality reproduction from radio and gramophone, limited number; reduced price includes all valves.—Bakers Selhurst Radio, 75, Sussex Rd., South Croydon. [19809]

**RECEIVERS & AMPLIFIERS—SECONDHAND, ETC.**  
**MURPHY** A50, little used, perfect; offers.—Box 2659, c/o *Wireless World*. [19975]

**"TROPHY 6,"** as new; best offer secure.—Offers Box 2645, c/o *The Wireless World*. [19957]

**HALLICRAFTER** Sly Champion Receiver For Sale; offers, highest cash, to Baintree Broadcast Relay Service, Ltd., London Rd., Baintree, Essex. [19331]

**"WIRELESS WORLD"** Q.A. Super with 6 watts push-pull amplifier, triode output, complete with 11 valves; £19/10, or with natural oak radiogram cabinet; £25. Various components also for sale. Box 2645, c/o *The Wireless World*. [19962]

**Wanted**

**WANTED.** Modern Communications receivers, one D.C., one A.C.—Penton, Derbyhaven, Isle of Man. [19951]

**HALLICRAFTER** SX17 or Similar Required.—Details and price to Box 2642, c/o *The Wireless World*. [19956]

**AMPLIFIER,** 15w.-20w.—Particulars and price to H. Pearson, "Pine View," Brandon Rd., Binley, Coventry. [19971]

**WE Offer Cash for Good Modern Communication and All-wave Receivers.—A.C.S. Radio, 44, Widmore Rd., Bromley.** [19948]

**SPOT Cash Offered for Radiogram.** State makers' numbers, condition. Good price paid.—Box 2649, c/o *The Wireless World*. [19966]

**UP to £100 Offered for Good Set, Autoradiogram or Radiogram.** Send fullest details.—State makers' numbers.—Box 2648 c/o *The Wireless World*. [19965]

**WANTED.** American Communication receiver, R.M.E. 69 preferred; top price offered for clean job.—Champion, 42, Howitt Rd., London, N.W.3. [19978]

**ALL Mains Set Wanted Immediately.** Give full details, maker's model number, condition. Will pay fair price.—Box 2650, c/o *The Wireless World*. [19967]

**HALLICRAFTERS** SX28 or SX17, Midwest or similar receiver, signal generator, Oscillograph, Meissner ganged coils.—Box 2646, c/o *The Wireless World*. [19963]

**NEW or Used Receivers, Amplifiers, Meters, Converters, Radio & Electrical Accessories.** Very high prices paid for really clean apparatus.—Phone: Gerrard 4447. [19696]

**GOOD Spot Cash Price Paid Immediately for Multi Valve Chassis, Set or Radiogram, working order or otherwise.—Send full details, including maker's number, to Box 2647, c/o *The Wireless World*.** [19964]

**LONDON CENTRAL RADIO STORES** Will Pay good prices for Receivers, Radiograms, Amplifiers, Dynamos, Converters, Test Equipment, Electric Gramophone Motors, and all Radio and Electrical Accessories.—London Central Radio Stores, 25, Lisle St., London, W.C.2. Gerrard 2969. [19836]

**NEW MAINS EQUIPMENT**

**VORTEXION** Mains Transformers, chokes, etc., are supplied to G.P.O., B.B.C., L.P.T.B.; why not you? Imitated, but unequalled Orders can only be accepted against Government contracts.

**VORTEXION, Ltd.** 257, The Broadway, Wimbledon, London, S.W.19. 'Phone: Lib. 2814. [19942]

**MAINS EQUIPMENT—SECONDHAND**

**FOR Sale, D.C. converter, originally cost 15 gns., maximum 120 watts; needs rewinding; what offers? Seen Finchley.—Box 2639 c/o *Wireless World*.** [19944]

**Wanted**

**CONVERTER** 110v. D.C. input, to 110v. A.C. output, preferred with filter and soundproof cabinet; keenest price, please.—Sexton, 164, Gray's Inn Rd., W.C.1 [19941]

**TEST EQUIPMENT**

**COSSOR** Oscilloscope, Model 3332, prac. unused, new tube; first £30.—Vicar, Benenden, Kent. [19937]

**30/-**—Sifam moving coil milliammeter, 0-20, in perfect condition.—Box 2662, c/o *Wireless World*. [19960]



**L.R.S**  
**FOR ALL PUMPING PURPOSES**  
**The STUART CENTRIFUGAL ELECTRIC SHELTER PUMP**  
 has been proved by Government Depts., County Councils, Railway Cos. and private users to be the most effective. It's a sound job built for continuous running and will keep your shelter or cellar dry. Fan-cooled ball-bearing motor. Low current consumption. All parts non-rusting. Connections for rubber hose.  
**Please state exact mains voltage.**  
 No. 10, 100 gals. per hour Curr. 2½- extra ... £5 2 6  
 No. 11, 280 gals. per hour " 2½- " ... £6 6 0  
 No. 12, 560 gals. per hour " 3½- " ... £7 12 0  
 Prices include foot valve and strainer, and hose union. Pump is ready for immediate use.  
**Suitable Rubber Hose for these pumps is also available from stock.**  
**A Useful Accessory**  
 The STUART AUTOMATIC FLOAT SWITCH, dependable and easy to install, is the best method of controlling water-level. Immediately water rises in the sump the Float Switch starts the motor pump. Price, complete with all fittings, £2.5.0.  
 We have a small stock of the following  
**PHILIPS CYCLO DYNAMO LIGHTING SETS 36/-** or with larger lamp 42/- Postage 7d.  
**BELLING BOILING RINGS 33/-** Postage 1/-.  
 ● A very limited number of **AVOMINOR AC/DC UNIVERSAL TEST METERS** is available from stock. Price £6.10.0. Plus 10d. regd. post.  
 Cash or C.O.D.  
 Send 2d. stamp for illustrated price lists.  
**LONDON RADIO SUPPLY CO.**  
 Est. 1925  
 "WINDEN," ARDINGLY RD., BALCOMBE, SUSSEX

**ARMSTRONG**  
 We still have a limited number of new and unused component parts, as below:—  
 Genuine Low Loss 3-gang .0005 Tuning Condensers with Ceramic insulation, as fitted to our AW125 chassis, and can be used for any purpose where a high quality condenser is required. Price 12/6. Or with dual ratio slow-motion drive, 17/6.  
 Aluminium Screens, 6½ x 6½ in. with 3/16 right angle edge. Suitable for constructing screening boxes, etc. Price 5/- per half-dozen.  
 Glass Tuning Scales, 7½ x 4½ in. Station names and metres. Types to cover, 2, 3 and 4 wavebands. Price 3/6.  
 465 kc. High "Q" IF Transformers, Litz wire wound, fitted with Iron Cores and Ceramic insulated trimmers. Price 18/6 pair.  
 465kc. Standard IF Transformers. Litz wire wound, complete with trimmers. Price 10/6 pair.  
 Steel Chassis. Heavy gauge, cadmium plated and drilled as follows—Amplifier chassis, 15 x 13 x 3½ in., drilled 12v. Price 8/6.  
 Radio chassis, 12 x 7 x 3½ in., drilled 4v. Price 4/6.  
 Radio chassis, 10 x 7 x 2½ in., drilled 7v., 2IF and transformer. Price 5/6.  
 Special EXP48 chassis, 10/6.  
**SPECIAL OFFER!** Amplifier Chassis in heavy gauge steel, cadmium plated, 17½ x 10 x 3½ in., drilled 13v., transformer, choke and recessed at one end for speaker. Also suitable for experimental "hook-ups." Price 5/6 postage 1/-. Reduced prices for one dozen or over.  
 Latest Type Wavechange Switches operated by Press Button mechanism of robust construction. Suitable for switching aerial and oscillator circuits on 4-wave-band receivers. Equally suitable for many other purposes. Supplied complete with knobs and bronze escutcheon. Price 8/6.  
 Metal Screening Cans. Brand-new. 3½ in. x 2½ in., complete with bases. 4/6 per dozen. Postage 0d.  
 \*  
**ARMSTRONG MANUFACTURING CO.**  
 WALTERS ROAD, HOLLOWAY, LONDON, N.7  
 'Phone: NORT 3213

**INSTRUMENT CASES**  
 to specification  
**LOCKWOOD & CO.**  
 LOWLANDS ROAD, HARRŌW, MDDX.  
 'Phone: BYRON 3704



There is delay in delivering our products, and dealing with correspondence, but our address is still:  
**THE COURTS, SILVERDALE LONDON - - - S.E.26**  
 'Phone: BYDenham 6666.



+ + +  
P. A  
PLUS

Whatever feature attracts your attention in R.S. equipment the "plus" factor is immediately apparent. In appearance, performance and reliability R.S. reaches a standard which few seek to attain.

**R.S.**

*Amplifiers Limited*

3-4, Highfield Rd., Shepperton, Middlesex  
Telephone: Wat-on-Thames 1019



## FOR THE RADIO SERVICE MAN, DEALER AND OWNER

The man who enrolls for an I. C. S. Radio Course learns radio thoroughly, completely, practically. When he earns his diploma, he will KNOW radio. We are not content merely to teach the principles of radio, we want to show our students how to apply that training in practical, every-day, radio service work. We train them to be successful!

### INTERNATIONAL CORRESPONDENCE SCHOOLS

Dept. 38, International Buildings,  
Kingsway, London, W.C.2

Please explain fully about your instruction in the subject marked X.

Complete Radio Engineering  
Radio Service Engineers

Elementary Radio Television

If you wish to pass a Radio examination, indicate it below.

Inst. of Wireless Technology

P.M.G. Certificate for Wireless Operators

Provisional Certificate in Radio Telephony and  
Telegraphy for Aircraft

City and Guilds Telecommunications

Name..... Age.....  
Address.....

(Use penny stamp on unsealed envelope)

F. H. WILSON, 51-52, Chancery Lane, London, W.C.2. Phone: Hol. 4631.

B.I. Tubular Condensers, N.L. 0.0001, 0.0002, 0.0003, 0.0005, 0.005, 0.001, 0.05; 5d. each.

T.C.C. Tubular Condensers, 0.00015, 0.01, 5d. each; 0.1, 7d. each; 0.25 5d. each; 0.5mid. 1/- each.

T.C.C. Tubular Electrolytics, 25mid. 25v., 1/6 each; 50mid. 25v., 1/9 each; 25mid. 50v., 1/9 each; 50mid. 12v., 1/6 each; 2mid. 300v. working, 1/6 each.

MICA Condensers, T.C.C. 0.0002 tag condensers, 6d. each; Hunts 0.0005 wire ended, 6d. each.

PHILLIPS Dual Range Aerial Coils (no reaction) with air space trimmer (circuit); 1/6 each.

PHILLIPS Three Waveband Oscillator Coil, 3 air space trimmer circuit; 3/- each.

PHILLIPS 130 K.C. Intermediate Frequency Transformers, air space trimmer; 1/6 each.

YAXLEY Type Switch Locators; 6d. each.

REX Type Switch Units, 2-bank, 4-pole, 3-way, used but perfect; 1/- each.

STRAIGHT Line Dials, 3 waveband; 1/6 each.

VALVE Holders, English chassis type, 4-pin 4d. each, 5- and 7-pin 6d. each; English Octal, 6d. each; American U.X. type, 4-, 5-, 6- and 7-pin, and International Octal, 6d. each.

ENGLISH Baseboard Valve Holders, assorted makes, 4- and 5-pin; 4d. each.

TRANSFORMERS, L.F. intervalve, various makes and ratios, including Class B. and Q.P.P.; 5/- each.

6-WAY Battery Leads with Plugs; 1/6 each.

TAPPED Mains Dropping Resistances, approx. 800 ohms, standard for Pye, Lissen, etc., 2-amp.; 3/6 each.

ALSO in Stock Replacements for G.E.C., Ferguson and Decca, 3-amp.

NEW Line Mains Transformers—while they last—350-0-350v., 4v. 4a., 4v. 2a., 30/100m.a., input 200/250v., 40-100 cycle A.C. high insulation; at £1.

MAINS Transformers by Phillips, 350-0-350, centre tapped, two 4v. and one 5v. L.P. windings, 80/100ma., standard input A.C.; 17/6 each.

TRANSFORMERS, various, by Varley and Ferranti, mains and output.

RESISTORS, different values, 1/4-watt 3d. each; 1-3-watt 4d. each, 1/2-watt 6d. each, 1-watt 8d. each.

FERRANTI Wire Wound Resistors, cartridge type, with holder; 2/6 each.

A.E.P.U. or L.S. Paxalin Strips, complete with plugs; 8d. each.

TERMINAL Strips and Group Boards; from 5d. to 1/.

DUAL Range Coils, by Varley, Telsen, Lissen, Colvern, iron and air core, single, twin and triple gang matched, various prices.

VARIABLE Condensers, 2-gang, 0.0005, 2/11 each; 3-gang, 0.0005, 3/11 each.

INTERMEDIATE Frequency Transformers (iron cored), 465 Kcs., used but perfect; 5/11 each.

ALL Orders and Enquiries Must Include Sufficient Postage.

F. H. WILSON, 51-52, Chancery Lane, London, W.C.2. [9972]

MODERN Components, £60 worth, unused, £20 for quick sale; Acorn triodes and pentodes, new, unused, £2 each.—Box 2640, c/o Wireless World. [9953]

COULPHONE Radio, New Longton, nr. Preston.—Brand new goods only; 8in. Plessey and Goodmans P.M. speakers, with transformer, 22/6; electrolytics, 500v. 4mf. 4/6, 3+3 mf. 8/6, 50 mf. 50 volt 3/3; Erie 1-watt resistors, all values, 8d. each; Tungram valves, stale requirements; S.A.E. for stock list. [9836]

#### Wanted

MILLER, Eastbourne Terrace, Seaford.—Peto-Scott or similar preselector, all-wave oscillator covering I.F.s. [9950]

WE Buy New or Used Radios, amplifiers, meters, converters, radio and electrical accessories, etc.—Phone: Ger. 4447. [9603]

#### CABINETS

WE Regret That, owing to all our employees having joined H.M. Forces, we are unable to accept orders for cabinets except to callers. Limited stock only. We have a large stock of radio components.—H. L. Smith and Co., Ltd., 289, Edgware Rd., London, W.2. Tel.: Pad. 6891. [6683]

#### DYNAMOS, MOTORS, ETC

ALL Types of Rotary Converters, electric motors, battery chargers, petrol-electric generator sets, etc., in stock, new and second-hand.

WARD, 37, White Post Lane, Hackney Wick, E.9. Tel.: Amherst 1393. [0518]

## YOU MUST KNOW "MATHS"

We have already trained hundreds of men for radio duties with the R.A.F. and other vital war-time services. Now, in response to many requests, we have introduced new Mathematical Courses.

If you wish to join the R.A.F., or increase your efficiency in other war-work, you must know Mathematics. By our simplified method of Home Studying, you can at last learn Mathematics or Radio really thoroughly, in your spare time.

Waste no time, but post coupon now for free details of our Home-Study Courses in Mathematics, Radio Calculations, Radio Servicing, Radiolocation, Television and Transmission.

★ If you are not liable for service, there are excellent opportunities for you to earn good money in your spare time as a Service Engineer.

## T. & C. RADIO COLLEGE 29, Market Place, READING

(Post in unsealed envelope, 1d. stamp)

Please send me free details of your Home-Study Radio Courses.

NAME.....

ADDRESS.....

W.V.4.....

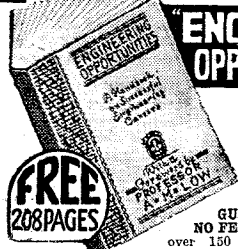

**FREE**  
208 PAGES

### ENGINEERING OPPORTUNITIES

This unique Handbook shows the easy way to secure:

A. M. I. C. E.  
A. M. I. Mech. E.  
A. M. I. E. E. A. M. I. A. E.  
A. M. I. Brit. R. E. E. and similar qualifications. WE GUARANTEE—'NO PASS—NO FEE.' Details are given of over 150 Diploma Courses in all branches of Civil, Mech., Elec., Motor, Aero., Radio and Production Engineering, Draughtsmanship, Tracing, Inspection, Government Employment, BUILDING (great scope), MATRIC, R.A.F. MATHS, etc. Write for this enlightening Handbook to-day, FREE and post free. Men with Radio Knowledge can obtain attractive posts in the Services.

**BRITISH INSTITUTE OF ENGINEERING TECHNOLOGY, 387, Shakespeare House, 17, 18, 19, Stratford Place, London, W.1**

## ARDUX HOLDS METAL INSERTS IN PLASTIC MOULDINGS

**AERO RESEARCH LIMITED**

PIONEERS OF SYNTHETIC ADHESIVES

DUXFORD CAMBRIDGE TELEPHONE SAWSTON 109

TRIX

EQUIPMENT

**RELIABLE AMPLIFICATION**  
The TRIX ELECTRICAL COMPANY LTD.  
65, Bolsover St., London, W.1. Euston 5471

**DYNAMOS.**—12, 25, 50, 100 and 230 volts up to 5 kw., battery charging or direct; alternators to 250 volts 3 kva.—Below.

**MOTORS.**—All voltages to 500 and up to 10h.p. A.C. or D.C.; by Century, Brook, Crompton, etc.—Below.

**ROTARY Converters.**—230 D.C. in, 230 A.C. out; 2,000 watts, £35; 1,000 watts, £25; 500 watts, £15; several others, all voltages, down to 40 watts.—Below.

**LIGHTING Sets.**—Petrol, paraffin, or oil, by Petter, Lister, etc.; automatic sets by Kohler, Delco, etc.—Below.

**ALSO** Meters, battery chargers, transformers, resistances, etc.—H. Harris, Strouds, Bradford, Berks. [9946]

**REPAIRS AND SERVICE**

**L.T.P.** Repair All Mains Transformers and Chokes. Prompt delivery.

**LONDON TRANSFORMER PRODUCTS, Ltd.,** Willesden, N.W.10. Wil. 6436 (3 lines). [9552]

**MAINS,** output transformers, chokes, etc., rewound.—Davies, 30, Morley Av., Manchester, 14. [9700]

**MIDWEST,** etc., we are the American experts.—Bennett's, 4, Humberstone Drive, Leicester. [9954]

**METROPOLITAN RADIO SERVICE Co.** Guarantee Repairs to American and British Receivers. —1,021, Finchley Rd., N.W.11. Spe. 3000. [9641]

**TRANSFORMERS,** pick-ups, motor rewinds, repairs of all descriptions to the wireless trade.—Marshall, 137, Windmill Lane, Nottingham. [9842]

**MAINS** Transformers Service, repairs, rewinds, or construction to specification of any type, competitive prices and prompt service.—Sturdy Electric Co., Ltd., Dipton, Newcastle-upon-Tyne. [9651]

"**SERVICE with a Smile.**"—Repairs of all types of British and American receivers; coil rewinds; American valves, spares, line cords.—F.R.I., Ltd., 22, Howland St., W.1. Museum 5675. [8934]

**SITUATIONS VACANT**

**APPLICATIONS** are invited by the Home Office for the following posts, connected with a system of wireless communications.

**TECHNICAL** Assistant (Wireless) (D.314).

**APPLICATIONS** should have had a good education and possess sound knowledge of modern wireless theory and practice, including transmitters, especially V.H.F.

**AT** least three years' executive experience in a commercial research and development laboratory or in the engineering branch of a Government or commercial wireless station, is essential.

**REGIONAL** Wireless Engineer (D.316).

**APPLICATIONS** must be of good education and have sound knowledge of wireless transmission and reception, including radio-telephony; practical experience in both medium and V.H.F.; good knowledge of Morse (20 w.p.m.) and installation and electrical work; must have sufficient organising ability to administer the station and staff.

**STATION** Engineer (Wireless) (D.317).

**APPLICATIONS** must be of good education, have sound knowledge of wireless, including radio-telephony, both medium and V.H.F., and of electrical fitting work; good knowledge of Morse (18 w.p.m.).

**THE** salaries offered will be according to qualifications and experience.—Applications, giving details of experience and salary required, should be addressed to the Secretary, Central Register, Section D.314/6/7, Queen Anne's Chambers, Westminster, S.W.1. [9935]

**HEAD** Foreman with Radio Assembly Experience, war work, North Wilts, state experience, salary required in confidence.—Box 2657, c/o *The Wireless World*. [9968]

**DEPARTMENTAL** Manager Required for Electrical Instrument Section of Factory Engaged on Essential Work in N.W. District.—Write with full particulars to Box 2657, c/o *Wireless World*. [9932]

**SITUATIONS WANTED**

**MAN,** 35, exempt Military Service, 15 years' managerial and large staff control experience, in present trade (London), now concentrated, knowledge radio and electricity; A.T.C. civilian instructor (signals).—Box 2658, c/o *Wireless World*. [9974]

**TUITION**

**RADIO** Training.—P.M.G. exams, and I.E.E. Diploma, prospectus free.—Technical College, Hull. [0611]

**MORSE** Code Training in Your Own Home; "Book of Facts" free.—Candler System Co. (W.O.) 121, Kingsway, London, W.C.2. [9744]

**PRACTICAL** Radio Postal Courses, coaching for I.P.R.E., R.A.F., A.I.D. exams; booklet free.—Secretary, I.P.R.E., Bush House, Walton Avenue, Henley-on-Thames [9547]

**ELECTRADIX Battersea Bargains**

**110 VOLT D.C. DRILLS.** Wolf Heavy Bench type, massive rack-gear rise and fall stand, motor drill socket. Capacity, jin. steel. 20 for immediate delivery. £7 10s. each.

**FRACTIONAL H.P. MOTORS.** D.C. 50-volt, enclosed type, 1/40 h.p. Navy, 2,500 revs., 15/-, 50 volts, 1/20 h.p. shunt K.B., 24/-. 50/50 volts, 1/5 h.p.—shunt Crypto, 1,500 revs., 27/6, 110 volts 1/2 h.p. Maudslayi, shunt high-speed, 4,000 revs., 45/-, 230 volts, 1/12 h.p. Croydun, 2,500 revs., 30/-, 220 volts, 1/6 h.p. K. Blackman, geared, 1,250 revs., 45/-, 240 volts, 1/3 h.p. Century, 1,440 revs., 55/-, 220 volts, shunt 1/6 h.p. Keith B., 1,250 revs., geared to 80, 45/-, 230 volts, 1/4 h.p., induction, self-start, Trips 32/6.

**A.C. MOTORS.** Cent. Midget Induction, 1/100 h.p., 30 volts, 58 revs., 15/-, 230 volts, 1/4 h.p., induction, self-start, Trips 32/6.

**DYNAMOS.** D.C. 15-volt, 15 amps, 3rd brush Letiner type, heavy charger, 70/-, 30-volt, 5 amps, Crypto double-shaft, 1,350 revs., 60/-, Double-current, L.T.-H.T. aircraft type, 6.25 v. generator high-speed, special high-speed, Wind Dynamos, 3rd brush, Unused, 15/-.

**BUZZERS FOR SIGNALS.** Cambridge-Townsend midget high-note buzzer is smallest made and used by Govt. for wavemeters. 10/-.

**PRACTICE BUZZERS,** bakelite case, 3/6. Brass cased panel buzzer, 4/6. Heavy type, bakelite cased, 5/6. D.3 Buzzers, multi-windings, but no contacts, 5/6.

**DICTAPHONE SOUND AMPLIFIERS** and horn for loud use with buzzers, 7/6.

**MORSE TAPPER SIGNAL KEYS** for A.P.C. type B.I. 5/-, Type M. 6/6, Type P.F. 9/6, Type I.V. 12/6. **CRYSTAL B.B.C. sets,** 15/-, Field Phones and Cable, Signal Lamps and Earth Spikes.

**MULTI-SWITCH** 8-way boxes, Lucas change-over and fuses, 3/6. 6-way push button R.A.F. aero, 2/9.

**SOLENOIDS** for remote control, 12 volts, 2in. plunger, 1/4in. dia. compound wound, 3/6.

**SCOUTS' TELESCOPES** with tripod, 5 lens, 1 draw 12in. 5/6. Postage 9d.

**VARIABLE CONDENSERS.** .0005 mfd. S/W condensers, 3/6.

**VALVES.** "Waco" Triode general purpose, new, 1 volt midgets, 4-pin, 3/6. 6 volt Power Triodes, 4/6. Neon Lamps, 230 volt letters, 2/6. Pocket Thermometers, in metal case, 2/6. Ceiling Roses, porcelain, 15/- extra. Carriage fwd.

**MORSE RECORDERS** for home training, on Service Model grammo-drive recording, direct dot-dash on paper, with dead key fitted, £3/10/-, Standard G.P.O. Transmitting Morse Inkers, £10/-.

**A few** Wheatstones and incomplete Teleprinter, Keys and Signal Lamps. **COME TO US FOR** Dynamos, Motors, Meters, Lab. Apparatus, Mikes, Rotaries, Switchgear and Chargers.

137 Bus or 31 Tram to—**ELECTRADIX RADIOS**  
19, BROUGHTON ST., Queenstown Rd., Battersea, S.W.8  
'Phone: Macaulay 2139.

**PHILCOPHONES WANTED**

Advertiser wishes to purchase a number of Philcophone loud speaking telephones or similar instruments, with or without extension speakers. State quantity and price to Advertiser, 27, Byrom St., St. John St., Manchester

**CLASSIFIED ADVERTISEMENTS** intended for the MAY issue can be accepted up to First Post on Wednesday April 8th.

**RADIO Engineering.**—Television and Wireless Telegraphy, comprehensive postal courses of instruction.—Apply British School of Telegraphy, Ltd., 179, Clapham Rd., London, S.W.9 (Estd. 1906). Also instruction at school in wireless for H.M. Merchant Navy and R.A.F. [9249]

**TECHNICAL TRAINING**

**GREAT** Possibilities Exist for Technically Qualified Engineers, key men in wartime and afterwards. Through the home-study courses of The T.I.G.B. take a recognised engineering qualification such as A.M.I.Mech.E., A. M. I. E. E., A. F. R. Ac. S., A.M.I.Chem.E., C. and G., etc., in which examinations the T.I.G.B. students have gained 25 FIRST PLACES and Hundreds of Passes. Write to-day for "The Engineer's Guide to Success"—Free—containing the world's widest choice of engineering courses covering all branches, including Aeronautical, Mechanical, Electrical, Wireless, Chemical, etc.

**THE TECHNOLOGICAL INSTITUTE OF GREAT BRITAIN,** 82, Temple Bar House, London, E.C.4. [9335]

**BUSINESSES FOR SALE OR WANTED**

"**THE** Wireless and Electrical Trader" is an essential part of the equipment of every Wireless Trader, its pages reflect the very latest turn of trade events, and it is read by all the leading dealers and manufacturers, for particulars of businesses offered or wanted. By subscription, to the trade only, 17/6 per annum, post free.—Send your trade card for specimen copy to Dorset House, Stamford St., London, S.E.1. [0614]

**MISCELLANEOUS**

**FERRANTI** 0-10, 0-50, 0-250, unused, 1941 transportable Decca radiogram, A.C., as new; offers invited.—Williamson, 30, Malvern Av., Flixton, Lancs. [9979]

**TORCH** Battery Cigarette Lighters. Make your own. Tested, lasting, efficient. Diagram and full instructions for easy home construction; 2/6; element included free.—Barham, Hilltop, Bradmore Green, Coulsdon. [9939]

**GENERATE** Free Electricity from the Wind; build your own wind electric charger, complete drawings, instructions for building, mast, head, vane, propeller; 2/6, postage 2/6d.—W. Pearce, Midtaphouse, Liskeard, Cornwall. [9970]

**BOOKS, INSTRUCTIONS, ETC.**

**WEBB'S** Radio Map of the World Locates any Station Heard. Size 40x30in., 4/6, post 6d.; on linen, 10/6, post 6d.—Webb's Radio, 14, Soho St., London, W.1. 'Phone: Gerrard 2089. [9647]

**EVERY** Radio Dealer Who is Not a Regular Reader of "The Wireless and Electrical Trader" should send his trade card at once for a specimen copy and full details of the "Trader" Services. "The Wireless and Electrical Trader" has the widest influence, and is read by all the leading manufacturers and traders. Trade only, 17/6 per annum, post free. Published at Dorset House, Stamford St., London, S.E.1. [0615]

**Picture Telegraphy Operators**

Wanted, Men 45-50, Newspaper, LONDON, MANCHESTER, GLASGOW.  
No Morse or previous experience necessary. Knowledge of amplifiers, telephone circuits required. Mention photographic, optical and mechanical experience. Salary £300-350 per annum.  
Box 2638, c/o "Wireless World."

**VALVES and SPARES**

**TUNGSTON, NATIONAL UNION AND PHILCO VALVES.** Most types except rectifiers in stock. Many free of tax.

Nearly all Philco, Aerial and H.F. Coils, I.F.s, Volume and Tone Controls, Fixed Condensers, etc.  
NO LISTS. Please send stamp and state requirements.  
**E. H. ROBINS TRADING Co. Ltd.**  
32 City Road Cardiff



**Acoustical**  
**MANUFACTURING COMPANY**  
ERMIN STREET, HUNTINGDON. Telephone: HUNTINGDON 361

for AMPLIFIERS, TRANSFORMERS AND ALL PA. EQUIPMENT

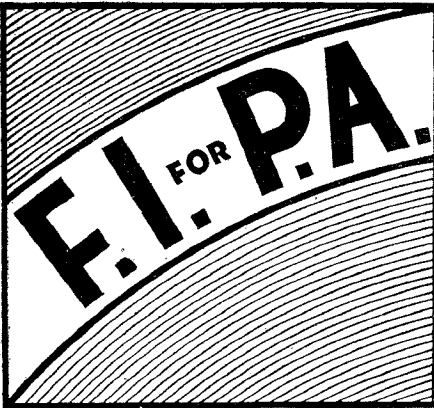

**HORN LOUDSPEAKERS**

\* \* \*

**MOVING COIL MICROPHONES**

\* \* \*

**FILM INDUSTRIES, LTD.,**

60, PADDINGTON STREET, LONDON, W.1.  
WELbeck 2385/6.



# Another 65-watt SOLON

This 65-watt industrial type SOLON is fitted with an oval tapered bit—a popular shape for all general work. Pencil bit types and heavier models are also available.

Details of this and other models sent on request.

Due to heavy demands, it is necessary to order well in advance to avoid disappointment in delivery.



MADE FOR USUAL STANDARD VOLTAGES

W. T. HENLEY'S TELEGRAPH WORKS CO. LTD.,  
Engineering Dept., Milton Court,  
WESTCOTT, DORKING, SURREY.

## PITMAN'S TECHNICAL

### GATHODE RAY OSCILLOGRAPHS.

By J. H. Reyner, B.Sc. (Hons.), A.C.G.I., A.M.I.E.E., M.Inst. R.E. Here is an easily understood guide to the practical application of Cathode Ray Tubes to numerous purposes, including the examination of oscillations or wave forms. Radio men, and particularly those about to enter the services, will find this book a genuine and invaluable guide. It has been given the highest recommendations both for students and teachers. *Electrical Times* says: "Anyone desiring a clear understanding of the Cathode Ray Oscillograph . . . cannot do better than purchase this moderately priced book." 8s. 6d. net.

### RADIO RECEIVER CIRCUITS HANDBOOK. Containing practical notes on the operation of basic modern circuits.

By E. M. Squire. A useful guide to circuits for members of the radio industry, and radio amateurs. By dealing with the receivers in stages the author has achieved the utmost clarity and conciseness. The text is liberally illustrated with circuit drawings and other diagrams. 4s. 6d. net.

### THERMIONIC VALVES IN MODERN RADIO RECEIVERS.

By Alfred T. Witts, A.M.I.E.E. Notes on the use of aligned grids, output, tetrodes, negative feedback and phase splitters for push-pull amplifiers have been added to the text of this new edition, which has been substantially modernised generally 10s. 6d. net. Second Edition.

**PITMAN'S PARKER STREET, KINGSWAY**

**F.H. WILSON**

for  
**QUALITY COMPONENTS & ACCESSORIES**  
SPECIAL TERMS  
to members of H.M. Forces and Civil Defence Services.  
Our technical advice is at your service.  
See also Classified Advertisement, page 22.

**51-52 CHANCERY LANE.**  
LONDON. W.C.2. Telephone H0LBORN 4631.

*This space reserved for*

**W. BRYAN SAVAGE LTD.**

---

**WARD ROTARY CONVERTERS**

Petrol Electric Generating Plants, H.T. Generators, D.C. Motors, Frequency Changers, etc., up to 25 K.V.A.

**CHAS. F. WARD 37 WHITE POST LANE,**  
Phone: Amherst 1393. HACKNEY WICK E.9.

**"COSMOCORD" CRYSTAL PICK-UP**

LICENSED BY BRUSH CRYSTAL CO., LTD.  
under Brit. Pat. Nos. 366,252 and 454,595



Retail Price **27/6** Plus Tax

Registered Wholesalers only supplied.  
**SOLE SELLING AGENTS:**  
**SALE, TILNEY & Co., Ltd.,**  
3, LLOYD'S AVENUE, LONDON, E.C.3.  
Phone: ROYAL 4811.

**THE SIMMONDS GROUP**

**INVENTORS**

We continually seek new inventions and products in all branches of industry for development and production by the manufacturing Companies of the Simmonds Group throughout the world.

**SIMMONDS DEVELOPMENT CORPORATION LTD.**  
BUSH HOUSE, W.G.2.



Printed in England for the Publishers, ILLIFFE AND SONS LTD., Dorset House, Stamford Street, London, S.E.1, by THE CORNWALL PRESS LTD., Paris Garden, Stamford Street, London, S.E.1. "The Wireless World" can be obtained abroad from the following: AUSTRALIA AND NEW ZEALAND: Gordon & Gotch, Ltd. INDIA: A. H. Wheeler & Co. CANADA: Imperial News Co.; Gordon & Gotch, Ltd. SOUTH AFRICA: Central News Agency, Ltd.; Wm. Dawson & Sons (S.A.), Ltd. UNITED STATES: The International News Co.

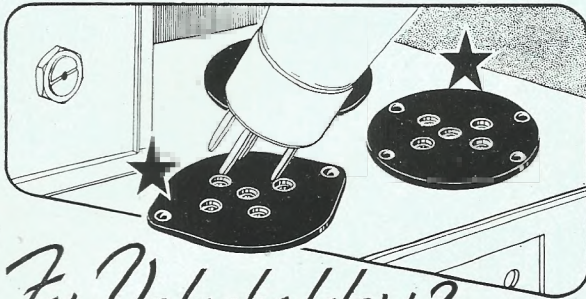

*For Valveholders?*

**DELARON**  
LAMINATED MATERIAL

*-naturally*

Countless valves stand four-square on Holders made from "DELARON" which is available in Fabric and Hard Paper Sheets in Air Ministry and Ministry of Supply approved grades. Special panels and strips gladly cut to order. Fullest details, samples and prices on request.



5, REGENT PARADE, BRIGHTON ROAD,  
SUTTON, SURREY. Tel.: VIGILANT 4472.

# B.I.

## RADIO MATERIALS

We have had a long experience in the manufacture of all kinds of Cables and Wires, Static Condensers, Insulators and Iron Work, Telephone Cords and Copper Earthing Rods, for Radio use.



U.K. Regd. Trade Mark.

**BRITISH INSULATED CABLES LTD.**  
CABLE MAKERS AND ELECTRICAL ENGINEERS  
Head Office:  
**PRESCOT, LANCS. Tel. No. PRESCOT 6571**

# ROLA

LOUD  
SPEAKERS

THE WORLD'S FINEST REPRODUCERS.

TRANSFORMER  
LAMINATIONS

Core Widths  $\frac{9}{16}$ " to  $1\frac{1}{2}$ " (E's and I's.)

EIGHT STOCK SIZES

A Comprehensive Bulletin together with details of Associated Covers and Clamps with design data will be sent to manufacturers on request.

BRITISH ROLA LIMITED

MINERVA ROAD · PARK ROYAL · N.W.10 · WILlesden 4322

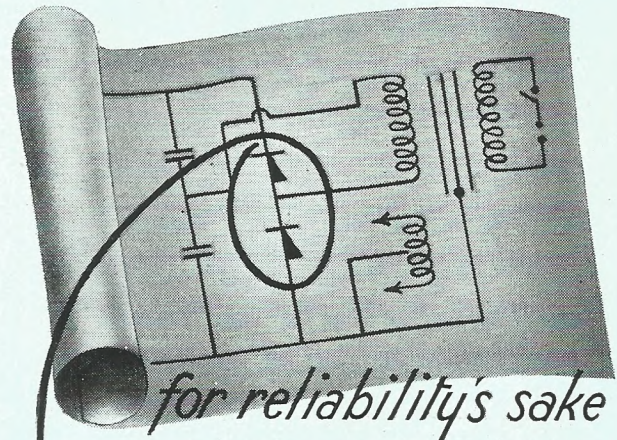

## PUT IT THERE

A Westinghouse Metal Rectifier as the power behind your mains receiver, means a constant H.T. supply without any rectifier renewals. Just instal it . . . then ignore it . . . it will last for years.

# WESTINGHOUSE NEEDS NO RENEWALS.

Send 3d. to Dept. W.W. for a copy of "The All Metal Way."  
WESTINGHOUSE BRAKE & SIGNAL Co. Ltd., Pew Hill House, Chippenham, Wilts.

**FREQUENTITE**

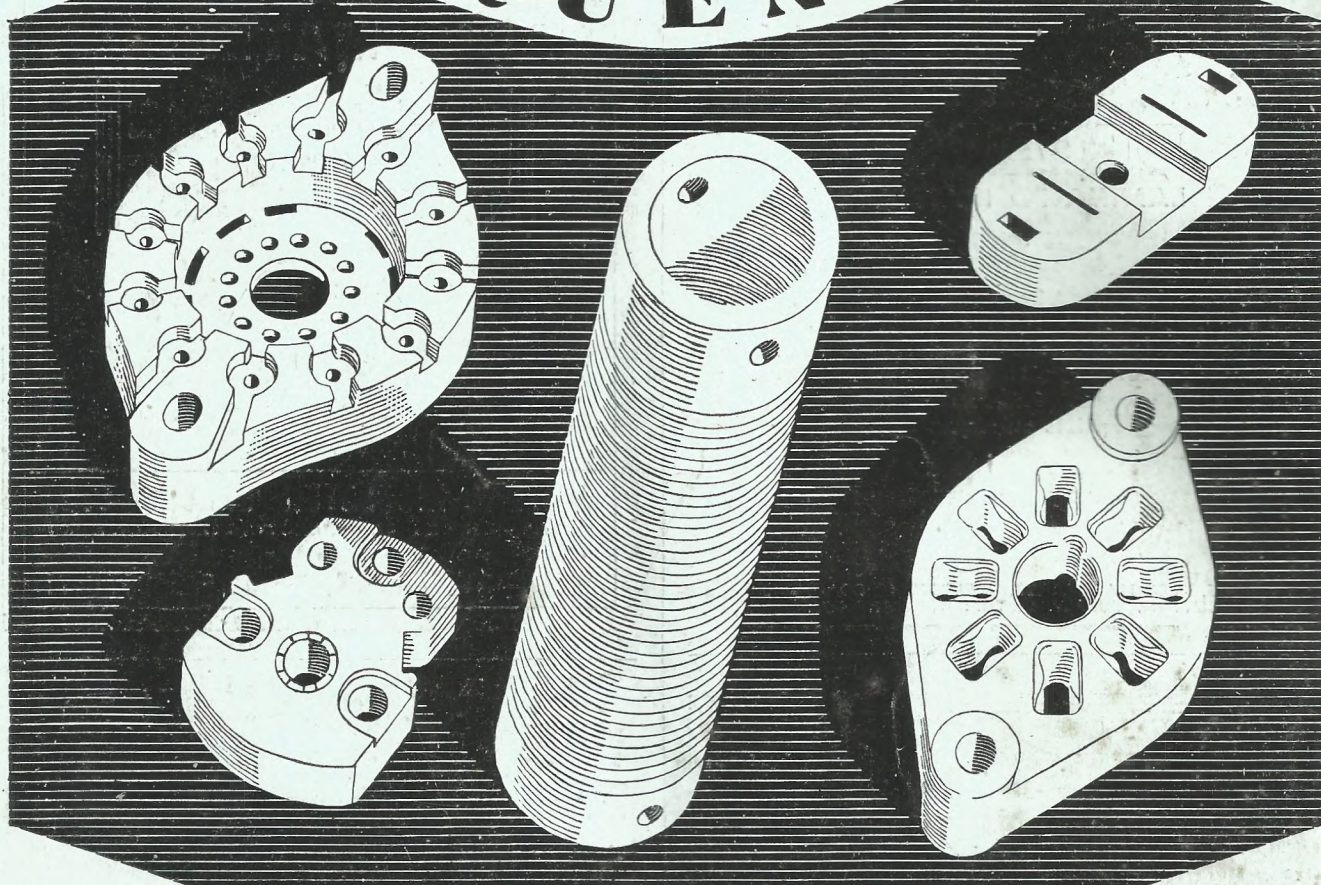

**THE PIONEER BRITISH-MADE LOW LOSS CERAMIC**

THE DEMAND for Frequentite, which possesses outstanding properties of Low Loss and High Mechanical Strength, continues to increase rapidly—and to be met. Production capacity has been stepped up over a period of years by extensions to plant, the employment of

specialised new equipment, and progressive improvements in manufacturing technique. Bulk supplies of the most intricate designs can be delivered promptly, and all manufacturers are invited to write for Catalogue No. S.P.10.

**STEATITE & PORCELAIN PRODUCTS LTD.**

Head Office :  
 Telephone : Stourport 111.      STOURPORT-ON-SEVERN, WORCS.      Telegrams : Steatain, Stourport.  
 SP.4